

HUNTING

PERFECTION IS
TRADITION
SINCE 1856

ANSCHÜTZ

EINFACH EINS WERDEN!

ENGLISH VERSION

HUNTING

TABLE OF CONTENTS

BIG BORE CALIBER 4

1782 4

1782 Gold Line.....	8
1782 Black Line.....	10
1782 GRS Bifrost.....	12
1782 Classic PRO.....	14
1782 Classic.....	14
1782 German stock.....	16
1782 Thumbhole stock.....	16
1782 Exclusive coatings.....	18
1782 Configurator.....	20
1782 Features.....	24

MEDIUM CALIBER 30

1771 30

1771 German stock.....	34
1771 Thumbhole stock.....	34
1771 GRS Sporter.....	36
1771 DJV.....	36
1771 Configurator.....	38
1771 Features.....	42

SMALL BORE CALIBER/RIMFIRE 46

1761 HUNTING MODELS..... 46

1761 Thumbhole stock.....	50
1761 Classic.....	50
1761 Monte Carlo.....	52
1761 Whisper.....	52
1761 Configurator - Hunting models.....	54

1761 HUNTING SPORT MODELS 58

1761 MP R Multi Purpose Beavertail.....	58
1761 MS R Silhouette Sporter.....	58
1761 Features.....	60

1727 F 66

1727 F German stock.....	70
1727 F Configurator.....	72
1727 F Features.....	76

SOUND MODERATORS 78

Model OBM48, cal. 6,5 mm - .30.....	80
Model ANSCHÜTZ cal. 4,5 - 5,5 mm.....	81

ACCESSORIES AND MERCHANDISE 82

Magazines.....	84
Firing pins, bolt breeches, trigger blades and guards.....	85
Bolt knobs and thread caps.....	86
Mounts and picatinny rails.....	87
Stocks.....	88
Sound moderators, stock and barrel accessories and cleaning.....	90
Transport.....	91
Clothing and Merchandise.....	92

CUSTOM SHOP 94

ASSOCIATED WITH HUNTING SINCE 1856

“Creativity” is the result of curiosity applied to a subject or task.

“When a new rifle is created at ANSCHÜTZ, there will have been dozens of creative moments and hundreds of decisions on the path to perfection. This can never be the work of just a single person - it is teamwork in perfection. Absolutely unthinkable without the curiosity and motivation of each and every co-worker!

Every one of them is a competence center at ANSCHÜTZ.

Even though we are justifiably very proud of the finished product: In principle, the route taken is the more important part. You can only achieve the goal yourself, in the process we always re-learn something and learn something new. The goal, however, sometimes has something final about it, and is thus “uncreative”.

I would like to thank our employees for their creativity!
And I would like to hope that you can detect how much creativity has been realised in our hunting rifles!”

Maximilian Anschütz

Maximilian Anschütz

6. Generation



ANSCHÜTZ

EINFACH EINS WERDEN!

1782

***ACCURATE AND RELIABLE
UNDER ALL CIRCUMSTANCES***

.243 Win. | 6.5 Creedmoor | 6,5 x 55 SE | .308 Win.

.30-06 | 8 x 57 IS | 9,3 x 62 | .300 Win. Mag.



"The continuous development and optimization of our products has the highest priority. The latest development in our hunting rifles is the 1782 Gold Line model, which impresses with an luxury optic and even smoother bolt movement - see for yourself!"

"Good hunting!"

1782

THE NEW DAY

The sky is reddening. Remnants of night-time grey, pale yellow. The morning dew hangs in the air and coats the wood on the hunting stand. Hoping for the first quarry.

An owl heard hours ago, a woodpecker hammers in the distance. The twilight is filled with waiting.

There! A branch moving against the wind! No rapid movement at all – not a word, no noise of any kind! Get your rifle. Time expands. Carefully change your position.

The game shows itself.

Aim. Release the safety catch silently, completely silently. Very good rifle! The correct choice. High-tech without pomp and grandeur, straightforward design, precise and rapid action. The eye looks through the telescopic sight, the finger on the trigger senses the two stage. Infinitely fine trigger adjustment. The stock radiates an intimate feeling and transfers to the body.

Waiting becomes concentration.

1782 GOLD LINE

EXCLUSIVE REFINEMENT, MAXIMUM DURABILITY

The 1782 Gold Line radiates elegance, individuality and impresses with its exclusive appearance. The gold-colored components are titanium nitrided (TIN). This optically very attractive titanium nitride is an all-round coating that has been tried and tested for decades thanks to its versatility and balanced properties. The attractive, golden color and the high abrasion resistance of this coating are ideal for the highly stressed components of the breech case, firing pin and trigger blade.

This exclusive overall package is rounded off with an elegant walnut bolt knob and premium wood grade stock, all of which are included in the Gold Line scope of delivery. The 1782 Gold Line can be configured with any stock design, barrel length and caliber as a right hand version.

*Gold
Line*



ANSCHÜTZ

EINFACH EINS WERDEN!

- 1 Non-slip rubber recoil pad
- 2 German stock, premium wood
- 3 Bolt handle lock
- 4 Sliding safety catch
- 5 TIN coated, gold-colored breech case
- 6 Barreled action milled from solid with integrated Picatinny rail
- 7 ANSCHÜTZ Precision barrel
- 8 Barrel thread M15x1
- 9 Studs
- 10 Non-slip checkering
- 11 Match single stage trigger 5082 D, 1.100g, with gold-colored TIN-coated trigger blade
- 12 Fast release magazine lever wich is integrated in the trigger guard
- 13 3-Shot Magazin made of stainless steel (caliber .300 Win. Mag. 2-shot magazine)
- 14 Gold-colored TIN-coated firing pin
- 15 Serrated, gold-colored TIN-coated trigger blade
- 16 Bolt knob made of beautiful grown walnut



1782 Gold Line configurations are also available in the wood grades Luxury and Meistergrade.



Shown: Model 1782 Gold Line, German stock in premium wood grade, caliber 8x57 IS, 470 mm barrel and barrel thread M15x1.



1782 Gold Line components

The individual Gold Line components trigger blade, firing pin and breech case (right-hand versions only) can be configured with new orders in all stock versions and all wood grade options, so that you can also benefit from the exclusive look of a gold-colored component in the stock version of your choice. See pages 18-19 for more information on each Gold Line component.

1782 GOLD LINE PRODUCT INFORMATION

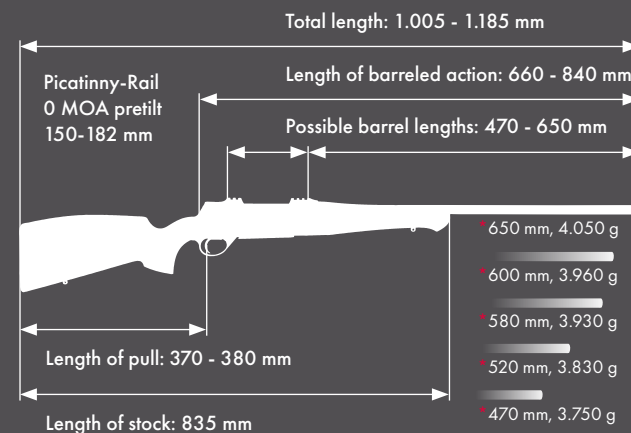

Single stage trigger 5082 D: factory set to 1.100 g



Total weight, depending on barrel length: 3.750 - 4.050 g



Two stage trigger 5082: factory set to 750 g adjustable from 750 - 1.200 g

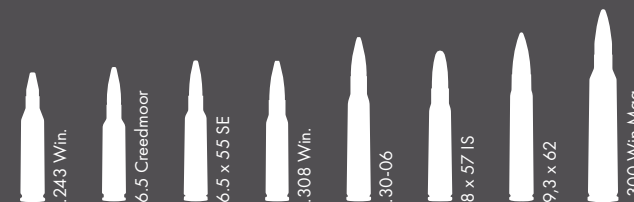

Important: Barrel lengths depend on caliber, not all lengths are possible for all calibers. For more information see page 20-21.

Scope of delivery:

Model 1782 Gold Line configurations come with a 3-shot magazine (with caliber .300 Win. Mag. 2-shot), thread protector, sling swivels, transport rifle case MEGA Version II (length: 118cm), original test target and quality control card.

1782 BLACK LINE

UNIQUE BOLT MOVEMENT

The 1782 Black Line is characterized by deep black DLC (Diamond Like Carbon) coated components. With the Classic PRO stock made of beautiful walnut and the height-adjustable black comb, you get an elegant and timeless overall package that is rounded off with a robust driven hunt magazine. The breech case, the trigger blade and the bolt knob are DLC-coated. The DLC coating gives these components a surface with excellent sliding properties and incredible hardness. This combination makes these highly stressed system components robust and resistant, and at the same time gives the bolt movement its unique, silky smooth and brilliant characteristics!

*Black
Line*



Model 1782 Black Line can be configured as right and left versions, **at no extra charge!**

ANSCHÜTZ

EINFACH EINS WERDEN!



1782 Black Line configurations are also available in the wood grades Luxury and Meistergrade.

- 1 Non-slip rubber recoil pad
- 2 Black, adjustable comb
- 3 Bolt handle lock
- 4 Sliding safety catch
- 5 Deep black DLC coated breech case
- 6 Barreled action milled from solid with integrated Picatinny rail
- 7 ANSCHÜTZ 470 mm Precision barrel
- 8 Barrel thread M15x1
- 9 Studs
- 10 Classic PRO stock made of oiled walnut
- 11 Non-slip checkering
- 12 Match single stage trigger 5082 D, 1.100g with deep black DLC coated trigger blade
- 13 Fast release magazine lever wich is integrated in the trigger guard
- 14 5-Shot driven hunt magazine made of stainless steel (caliber .300 Win. Mag. 3-shot magazine)
- 15 Deep black DLC coated trigger blade
- 16 Deep black DLC coated bolt knob



Shown: Model 1782 Black Line, caliber .308 Win., 470 mm barrel and barrel thread M15x1.



1782 Black Line components

The individual Black Line components trigger blade, bolt knob and breech case can be configured for new orders at any time in other stock versions, so that you can also benefit from the uniquely smooth bolt movement in the thumbhole stock, for example. See pages 18-19 for more information to each Black Line component.

1782 BLACK LINE
PRODUCT INFORMATION

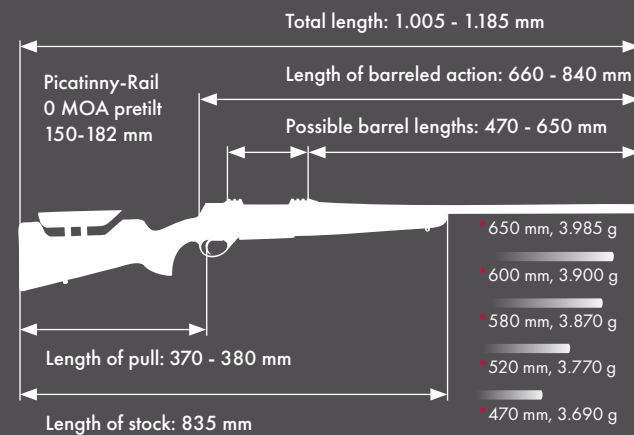

Single stage trigger 5082 D: factory set to 1.100 g



Total weight, depending on barrel length: 3.690 - 3.985 g



Two stage trigger 5082: factory set to 750 g adjustable from 750 - 1.200 g

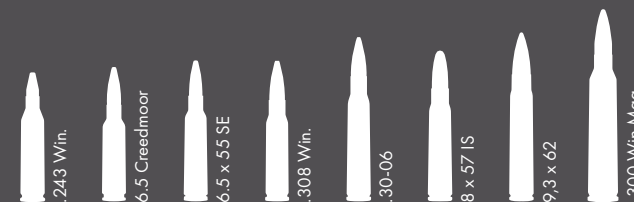

Important: Barrel lengths depend on caliber, not all lengths are possible for all calibers. For more information see page 20-21.

Scope of delivery:

Model 1782 Black Line configurations come with a 5-shot magazine (with caliber .300 Win. Mag. 3-shot), thread protector, sling swivels, transport rifle case MEGA Version II (length: 118cm), original test target and quality control card.

1782 GRS BIFROST

MADE FOR ANY SITUATION AND WEATHER

For friends of the modern synthetic stock. The Bifrost stock from the well-known stock manufacturer GRS is made of a fiberglass-reinforced composite material. Rubberized surfaces ensure a firm and secure grip when shooting. The SpeedLock 2.0 system allows the shooter to adjust the butt plate and cheek piece to his individual requirements and withstands any recoil without adjusting. Together with our high-precision 1782 barreled action, the result is a perfect and always reliable hunting companion, ready for the decisive moment.

GRS BIFROST



Shown: Model 1782 GRS Bifrost,
Caliber 6.5 Creedmoor, 520 mm
barrel and barrel thread M15x1.

ANSCHÜTZ

EINFACH EINS WERDEN!

- 1 Non-slip rubber recoil pad, adjustable in length
- 2 SpeedLock 2.0 System (push buttons) for adjusting the length of pull
- 3 Height-adjustable cheek piece for a relaxed head position. The cheek piece can be tilted sideways in 5° steps
- 4 SpeedLock 2.0 System (push buttons) for adjusting the cheek piece
- 5 Bolt handle lock
- 6 Sliding safety catch
- 7 Barreled action milled from solid with integrated Picatinny rail
- 8 ANSCHÜTZ Precision barrel
- 9 Barrel thread M15x1
- 10 Picatinny rail on the stock for mounting accessories
- 11 Sling swivel
- 12 GRS Bifrost stock made of fiberglass-reinforced composite material
- 13 Rubberized surfaces ensure for a firm and secure grip
- 14 Match single stage trigger 5082 D, 1.100 g
- 15 Fast Release due to integrated magazine release lever in the trigger guard
- 16 3-Shot magazine made from stainless steel (caliber .300 Win. Mag. 2-shot magazine)
- 17 Stud for the mounting of accessories
- 18 Sling swivel attachment on both sides, sling swivel included



Shown: Model 1782 GRS Bifrost, caliber 8x57 IS, 470 mm barrel and barrel thread M15x1.

The GRS Bifrost stock can be quickly adjusted. Depending on requirements, the height of the cheek piece or the length of pull can be individually adjusted by simply pressing the push buttons. The sling swivels can be mounted on both sides of the stock.

1782 GRS BIFROST

PRODUCT INFORMATION

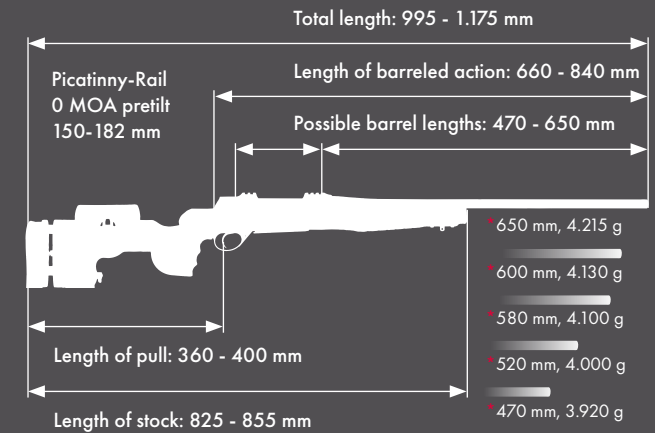

Single stage trigger 5082 D: factory set to 1.100 g



Total weight, depending on barrel length: 3.920 - 4.215 g



Two stage trigger 5082: factory set to 750 g adjustable from 750 - 1.200 g

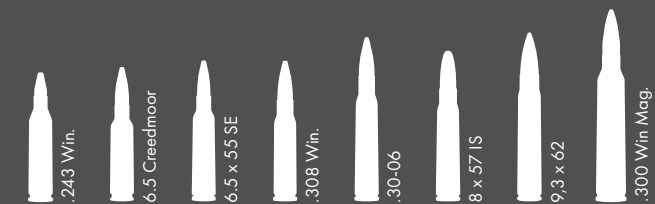

Important: Barrel lengths depend on caliber, not all lengths are possible for all calibers. For more information see page 20-21.

Scope of delivery:

The model 1782 GRS Bifrost is delivered, depending on the desired configuration, with sling swivels, transport rifle case Mega Version II (length 118 cm), original test target and quality control card.

1782 CLASSIC PRO WITH ADJUSTABLE COMB

Tradition and modern combined. This classic stock made of fine walnut wood has bestseller potential. The adjustable comb can be adjusted by the shooter to obtain the correct height for the perfect line of sight. The 1782 Classic PRO is available for both right- and left-handed shooters at no extra charge.

1782 Classic PRO "Black Line"

The 1782 Classic PRO model is also available with an attractive black cheek piece, for a modern and timeless look.



Model 1782 Classic PRO and Classic can be configured as right and left versions, **at no extra charge!**

ANSCHÜTZ

EINFACH EINS WERDEN!

- 1 Non-slip rubber recoil pad
- 2 Classic PRO stock with adjustable comb, made of oiled walnut
- 3 Bolt handle lock
- 4 Sliding safety catch
- 5 Hard-chromed fine-ground bolt with 6 locking lugs
- 6 Barreled action milled from solid steel with integrated Picatinny rail
- 7 ANSCHÜTZ Precision barrel
- 8 Barrel thread M15x1
- 9 Studs
- 10 Classic style stock, made of beautiful grown walnut
- 11 Match single stage trigger 5082 D, 1.100 g
- 12 Fast release magazine lever wich is integrated in the trigger guard
- 13 Fast release 3-shot magazine made from stainless steel (caliber .300 Win. Mag, 2-shot magazine)
- 14 Non-slip checkering



Shown: Model 1782 Classic PRO, caliber 9,3 x 62, 580 mm barrel and barrel thread M15x1.



Shown: Model 1782 Classic, caliber 6,5 x 55 SE, 520 mm barrel and barrel thread M15x1.

1782 CLASSIC WELL-BALANCED

The well balanced and ambidextrous oiled walnut stock. Looks traditional – looks good. For both right and left handed shooters. Straight-forward, effective, and well-balanced. Laser-cut, weather-resistant checkering for optimal grip. Recoil reducing no-slip recoil pad.

1782 MODELS PRODUCT INFORMATION

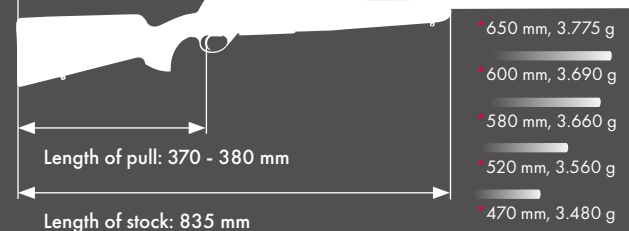
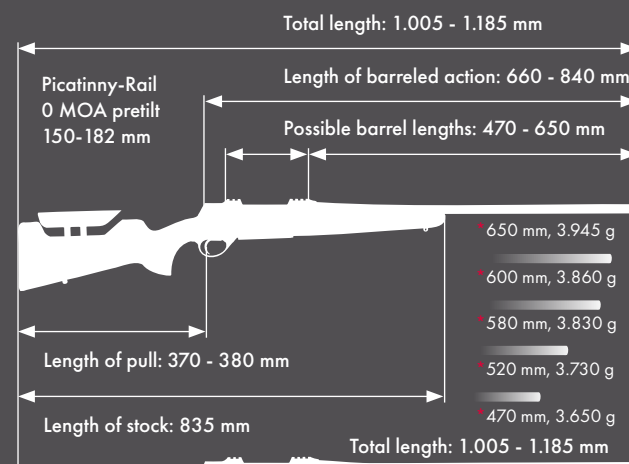

Two stage trigger 5082: factory set to 750 g adjustable from 750 - 1.200 g

Total weight, depending on barrel length: 3.480 - 3.945 g

Single stage trigger 5082 D: factory set to 1.100 g

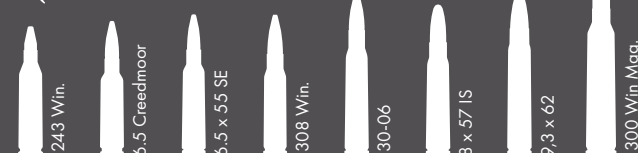

Important: Barrel lengths depend on caliber, not all lengths are possible for all calibers. For more information see page 20-21.

Scope of delivery:

Model 1782 configurations are delivered, depending on the desired configuration, with sling swivels, transport rifle case Mega Version II (length 118 cm), original test target and quality control card.

1782 GERMAN STOCK

BALANCED, AESTHETIC AND TIMELESS

Made from walnut from age-old forests, visually and functionally refined with a non-slip checkering. Hard and deformation-resistant, natural and individual. No stock is the same as any other. The rubber butt pad absorbs the recoil and holds the rifle securely in the shoulder when aiming.



1782 German stock

German style stock with bavarian cheek piece. This stock is a timeless and elegant masterpiece which completely satisfies in terms of ergonomics.



1782 Thumbhole stock

The ergonomically shaped roll-over cheek piece in combination with the steep, non-slip pistol grip and the generously dimensioned grip hole guarantees an excellent shooting position.

ANSCHÜTZ

EINFACH EINS WERDEN!

- 1 Non-slip rubber recoil pad
- 2 German style stock, made of beautiful grown walnut
- 3 Bolt handle lock
- 4 Sliding safety catch
- 5 Hard-chromed fine-ground bolt with 6 locking lugs
- 6 Barreled action milled from solid steel with integrated Picatinny rail
- 7 ANSCHÜTZ Precision barrel
- 8 Barrel thread M15x1
- 9 Studs
- 10 Thumbhole stock, made of beautiful grown walnut
- 11 Match single stage trigger 5082 D, 1.100g
- 12 Fast release magazine lever wich is integrated in the trigger guard
- 13 Fast release 3-shot magazine made from stainless steel (caliber .300 Win. Mag. 2-shot magazine)
- 14 Non-slip checkering



Shown: Model 1782 German Stock, caliber .30-06, 580 mm barrel and barrel thread M15x1.



Shown: Model 1782 Thumbhole stock, caliber 6,5 Creedmoor, 520 mm barrel and barrel thread M15x1.

1782 THUMBHOLE STOCK

A SYMBIOSIS OF STYLE AND FUNCTION

A futuristic design that incorporates the attributes of a classic. Quiet and precise stop. The trigger finger remains strain-free and movable; it doesn't have to support anything. As for the carefully selected and mature walnut wood: a gentle oil bath gives the stock its matt appearance and protects it from the elements.

1782 MODELS PRODUCT INFORMATION

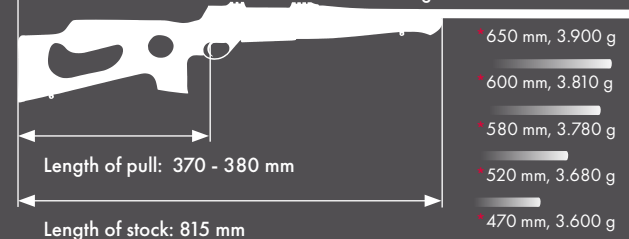
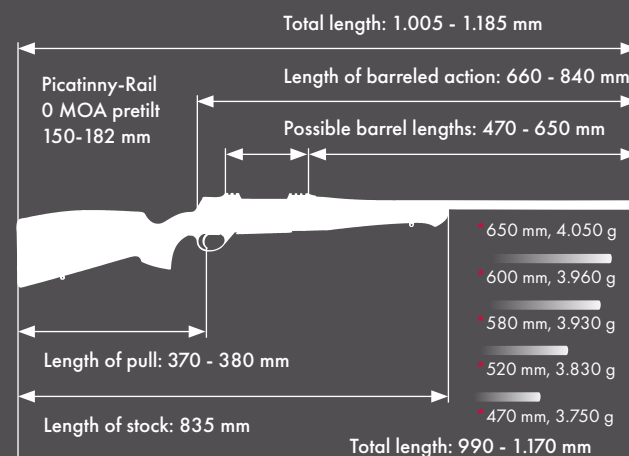

Two stage trigger 5082: factory set to 750 g adjustable from 750 - 1.200 g

Total weight, depending on barrel length: 3.600 - 4.050 g

Single stage trigger 5082 D: factory set to 1.100 g

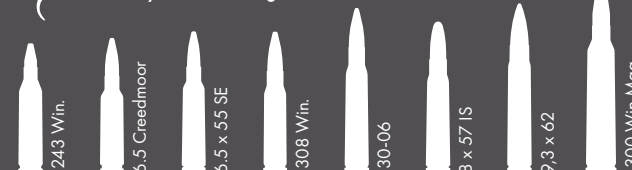

Important: Barrel lengths depend on caliber, not all lengths are possible for all calibers. For more information see page 20-21.

Scope of delivery:

Model 1782 configurations are delivered, depending on the desired configuration, with sling swivels, transport rifle case Mega Version II (length 118 cm), original test target and quality control card.

1782 BARRELED ACTION REFINEMENTS

EXCLUSIVE COATINGS

Give your 1782 an individual design and choose your desired coating when ordering. Whether classic silver-colored hard chrome-plated (standard), deep black with high-strength and extremely smooth DLC coating or with the timelessly elegant gold-colored TIN coating. In addition, specially designed trigger blades and bolt knobs are available.



1782 Standard version

The 1782 models are always delivered with a silver-colored nitrated trigger blade, a black synthetic bolt knob and the hard-chromed, silver-colored breech case.

1782 Gold Line version

Refine your 1782 with elegant Gold Line components. Whether the trigger blade, breech case, firing pin or bolt knob - configure which components should be TIN-coated when ordering.

1782 Black Line version

Equip your 1782 with Black Line action components. Elegant, deep black DLC-coated components that turn your 1782 into a timelessly elegant overall package. Furthermore, the DLC coating noticeably increases the gliding ability of the breech case - for an incredibly smooth bolt movement.



Standard



Gold Line

Black Line

1782 CONFIGURATOR

ACCORDING TO YOUR WISHES!

Technical data (depending on the configuration):

The total weight is between 3.460 g and 4.360 g.
The total length is between 990 mm and 1.200 mm.

For detailed information, please refer to the "Product information" section highlighted in gray on the previous product pages.

1. STOCK



Also available as a left hand version at no extra charge 

Classic - Right or left hand version
Length of pull 370 - 380 mm
Material Walnut, oiled
Wood grades (S) (P) (L) (M)



Also available as a left hand version at no extra charge 

Classic PRO - Right or left hand version
Length of pull 370 - 380 mm
Material Walnut, oiled
Wood grades (S) (P) (L) (M)



Also available as a left hand version at no extra charge 

Classic PRO - Black Line - Right or left hand version
Length of pull 370 - 380 mm
Material Walnut, oiled
Wood grades (S) (P) (L) (M)



German stock - Right hand version
Length of pull 370 - 380 mm
Material Walnut, oiled
Wood grades (S) (P) (L) (M)



Thumbhole stock - Right hand version
Length of pull 370 - 380 mm
Material Walnut, oiled
Wood grades (S) (P)



GRS Bifrost - Right hand version
Length of pull 360 - 400 mm
Material Synthetics

2. CALIBER

.243 Win.

Number of grooves 6
Twist rate 10"/254 mm



6.5 Creedmoor

Number of grooves 6
Twist rate 8"/203 mm



6,5 x 55 SE

Number of grooves 4
Twist rate 9"/220 mm



.308 Win.

Number of grooves 4
Twist rate 12"/305 mm



.30-06

Number of grooves 4
Twist rate 10"/252 mm



8 x 57 IS

Number of grooves 4
Twist rate 10"/240 mm



9,3 x 62

Number of grooves 4
Twist rate 14"/360 mm



.300 Win. Mag.

Number of grooves 6
Twist rate 10"/254 mm



Scope of delivery:

Your rifle-configuration, incl. transport rifle case MEGA Version II (length 118 cm), original test target and quality control card and a set of sling swivels 1".



3. BARREL LENGTH

470 mm (18.5 Inch) Barrel

Length of barreled action660 mm

Muzzle diameter 18 mm



470 mm barrel only with caliber .308 Win. / 8x57 IS

520 mm (20.5 Inch) Barrel

Length of barreled action710 mm

Muzzle diameter 18 mm



+

580 mm (22.8 Inch) Barrel

Length of barreled action770 mm

Muzzle diameter 18 mm



600 and 650 mm barrel only with caliber .300 Win. Mag.

600 mm (23.6 Inch) Barrel

Length of barreled action790 mm

Muzzle diameter 18 mm



650 mm (25.6 Inch) Barrel

Length of barreled action840 mm

Muzzle diameter 18 mm



+

4. MUZZLE OPTION

Recessed muzzle

High-precision manufactured muzzle that is slightly recessed in the center.



+

Barrel thread M15x1 with thread protector

The barrel thread allows you to quickly and easily assemble a sound moderator or a muzzle brake.



5. TRIGGER



Match single stage trigger 5082 D

Factory set to 1,100 g, silver-colored nitrided and non-slip serrated trigger blade, versatile adjustable.

+

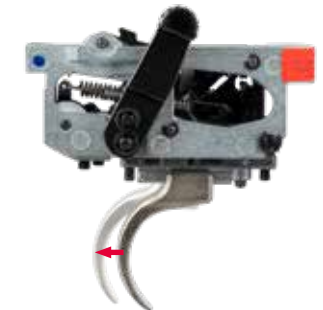

Match two stage trigger 5082

Factory set to 750 g, adjustable by an authorized gunsmith from 750 - 1,200 g, silver-colored nitrided and non-slip serrated trigger blade with versatile adjustment.



1782 CONFIGURATOR

ACCORDING TO YOUR WISHES!

6. MAGAZINE



1782 Magazine, Standard

3-Shot magazine made of stainless steel, for caliber .300 Win. Mag. 2-shot



1782 Driven hunt magazine

5-Shot magazine made of stainless steel with synthetic magazine base, for caliber .300 Win. Mag. 3-shot

7. WOOD GRADES

Wood grade Standard (S)*



Wood grade Premium (P)*



Wood class Luxus (L)*



Wood grade Meistergrade (M)*



* All wood grades shown are only examples. Wood is a natural product. Deviations in grain, wood structure and color within the ANSCHÜTZ wood quality grades are possible. The availability of the wood grades depends on the respective stock design. Further information at www.anschuetz-sport.com

8. BOLT KNOB



Standard

Made of high strength synthetic, 25 mm diameter, black.



Walnut

Made of walnut wood, 25 mm diameter.



Black Line

Deep black, DLC (Diamond Like Carbon) coated, 25 mm diameter.



Checkering and silver lines

With knurled checkering and elegant, timeless silver lines, 25 mm diameter.



Silver lines

With elegant, timeless silver lines, 25 mm diameter.



Checkering

With knurled checkering, timelessly elegant in black, 25 mm diameter.



Walnut

Made of walnut wood, 20 mm diameter.



Steel

Made of blued steel, 25 mm diameter.



Gold star

With knurled checkering, gold lines and elegant gold star, 25 mm diameter.



Checkering and gold lines

With knurled checkering and elegant, timeless gold lines, 25 mm diameter.



Gold lines

with elegant, timeless gold lines, 25 mm diameter.



APR

For fast repeating, with non-slip grooves, made of high-strength aluminum. Length 40 mm, Ø 22 mm.

9. THREAD CAP

When selecting the barrel with thread.



Standard

For barrel thread M15x1, made of blued steel with knurled checkering.



Silver lines

For barrel thread M15x1, made of blued steel with an elegant and timeless silver lines and knurled checkering.



Gold lines

For barrel thread M15x1, made of blued steel with an elegant and timeless gold lines and knurled checkering.



10. TRIGGER BLADE



Standard

Silver-colored, nickel-plated trigger blade with non-slip serrations.



Gold Line

Gold-colored TIN-coated trigger blade with non-slip serrations, the eye-catcher on your 1782.



Black Line

Deep black DLC-coated trigger blade without serrations, the simple but elegant detail on your 1782.



Gilded

Gold-coated trigger blade without serrations, an exclusive and luxurious highlight for your 1782.



11. BREECH CASE



Standard, for right and left-hand versions

Silver-colored, hard chrome-plated, breech case, classic and timeless.



Gold Line, for right and left-hand versions

Gold-colored TIN-coated, highest abrasion resistance, luxurious look.



Black Line, for right and left-hand versions

Deep black DLC-coated breech case with maximum gliding properties for an incredibly smooth bolt movement.



12. FIRING PIN



Standard

Made of high-strength steel, classic and timeless.



Gold Line

Gold-colored TIN-coated firing pin made of high-strength steel, an extraordinary addition for your 1782.





PRECISE INTERACTION

**MADE OF
WOOD AND STEEL**

1782

COMPLEX AND YET SIMPLE

Nothing convinces one more quickly and substantially than reduction, simplicity, purism - where nothing distracts and everything is pure concentration, every optical effect, every function. Such as with the ANSCHÜTZ centerfire hunting bolt-action rifle 1782. A hunting rifle that, in essence, consists purely of wood and steel.

Unpretentious and simple.

It is only with familiarization that one discovers the complexity of the 1782, and is amazed by its precision of modern engineering. Only then does the admiration increase, the owner's pride radiates in the unpretentious yet highly-complex rifle in his hands.

The 1782, a rifle that radiates calm and imparts competence. Welcomed attributes, so important during the hunt.

When we go hunting.

1782 ACTION

MADE TO WITHSTAND

Barreled action made from steel. Purity and quality - classically blued. Securely mated to the stock for outstanding shooting performance. Sturdy and resistant to heat and cold. Highly-precise surfaces that display elegance in design and allow the bolt to slide internally without any resistance. A reliable companion with unmatched precision and function. Timeless perfection! The integrated Picatinny rail enables flexible, simple and solid rifle scope mounting - even with attachments.

Bolt handle lock inactive

Bolt handle lock active

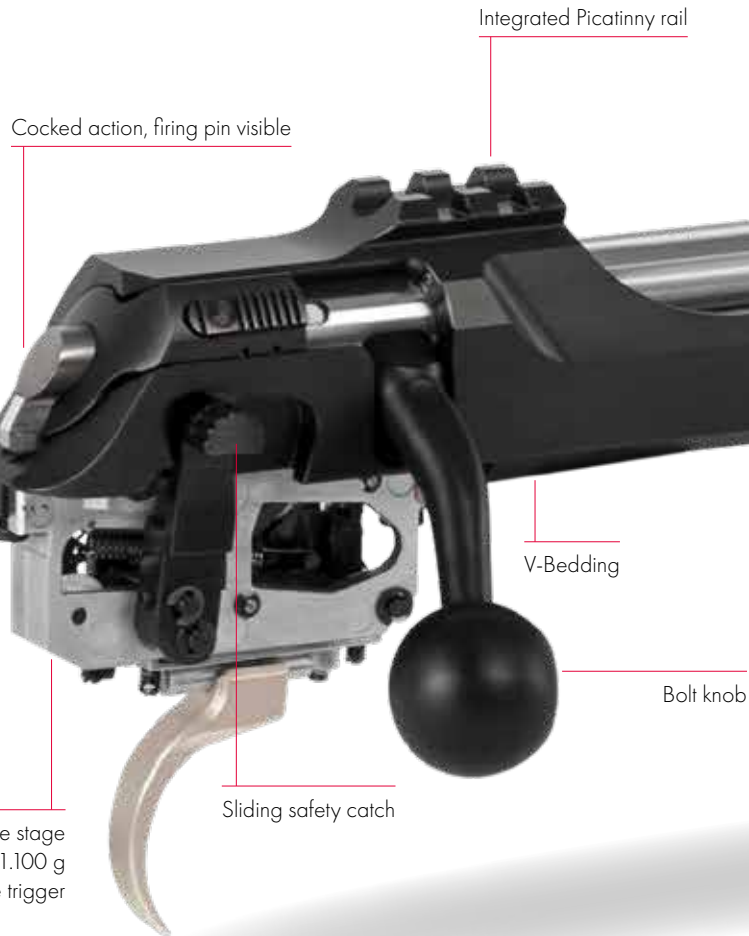

Bolt handle lock



60° bolt throw

1782 BOLT MOVEMENT

MOVING, SILKY SOFT, PRECISE, QUICK

A bolt movement that never fails to impress. Hard-chromed bolt, fine-ground for silky-soft repeating. Corrosion-protected. Two-row six locking lugs - a reliable, stable detail for the highest level of safety. On request available with gold-colored TiN or deep black DLC coating.



1782 MAGAZINE SIMPLE HANDLING, RAPID EJECTION

The magazine holds three cartridges, is made from sturdy stainless steel and is thus insensitive to dust, dirt and water. Convenient handling of the magazine as a result of the handy magazine base.

The magazine, which is located safely and securely in the magazine guide, is particularly easy to remove. Slight pressure with your index finger on the magazine release lever and the magazine slides out of the magazine guide!

Fast Release!

1782 Magazines available as 3-shot or 5-shot driven hunt magazines. For caliber .300 Win. Mag. 2-shot or 3-shot.

1782 PRECISION ANSCHÜTZ GUARANTEED

Before a 1782 leaves our factory in Ulm, each rifle is checked for shooting and safety; and then, the repeater receives the official proof house seal.

Before this can happen, we have already manufactured the 1782 so precisely, and assembled it so meticulously, that we are able to give each rifle a guarantee to take with it to the customer - **the ANSCHÜTZ guarantee of precision!**

It means that: Five shots, one after the other, will be a maximum of 1 MOA apart (center to center). In other words: The centers of the hits on the target are no more than 29 mm apart from each other!

For the following calibers, we guarantee, for 5 shots, maximum group sizes* of 1 MOA.

.243 Win. | 6.5 Creedmoor | 6,5 x 55 SE
.308 Win. | .30-06 | 8 x 57 IS | 9,3 x 62 |
.300 Win. Mag.



* shot using premium hunting ammunition

1782 TRIGGER PEAK OF THE ANSCHÜTZ COMPETENCE

Precision and refinement from high-performance sports - in summer and winter. Extremely wide adjustment range for the two stage and trigger weight. The location in the rifle with the decisive moment - high-precision parts in harmony in the tightest of spaces. For a single task! The perfect harmonization between man and rifle. Unparalleled.

There is nothing better.

- Trigger available as match single stage trigger 5082 D, factory-set to 1.100 g, or as match two stage trigger, factory-set to 750 g, adjustable by your gunsmith from 750 - 1.200 g
- Ergonomic and silent safety catch operation
- The trigger blade can be moved and swiveled

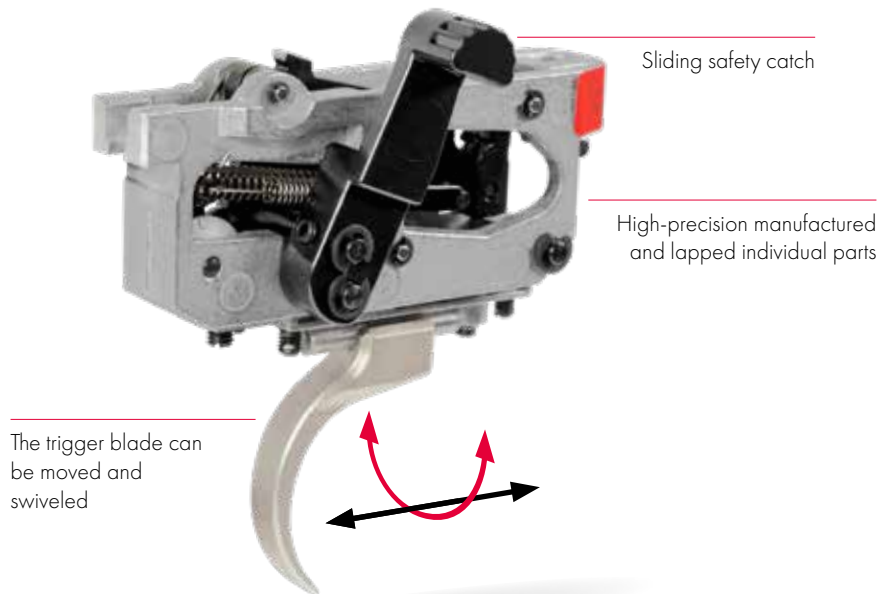

1782 THE STOCKS MAKE EACH RIFLE UNIQUE

Due to its qualities, Walnut is chosen from age old forests, then elegantly sculpted to form a balance between beauty and functionality with non slip checkering. Every stock rewards the senses, all are unique and distinctive.

The rubber butt pad absorbs the recoil and holds the rifle securely in the shoulder when aiming.

- Oiled walnut
- Solid aluminum action carrier with additional recoil lug for precise and sturdy bedding of the steel barreled action
- V-Bedding, an important guarantee for the overwhelming shooting performance
- Magazine release lever integrated in the trigger guard

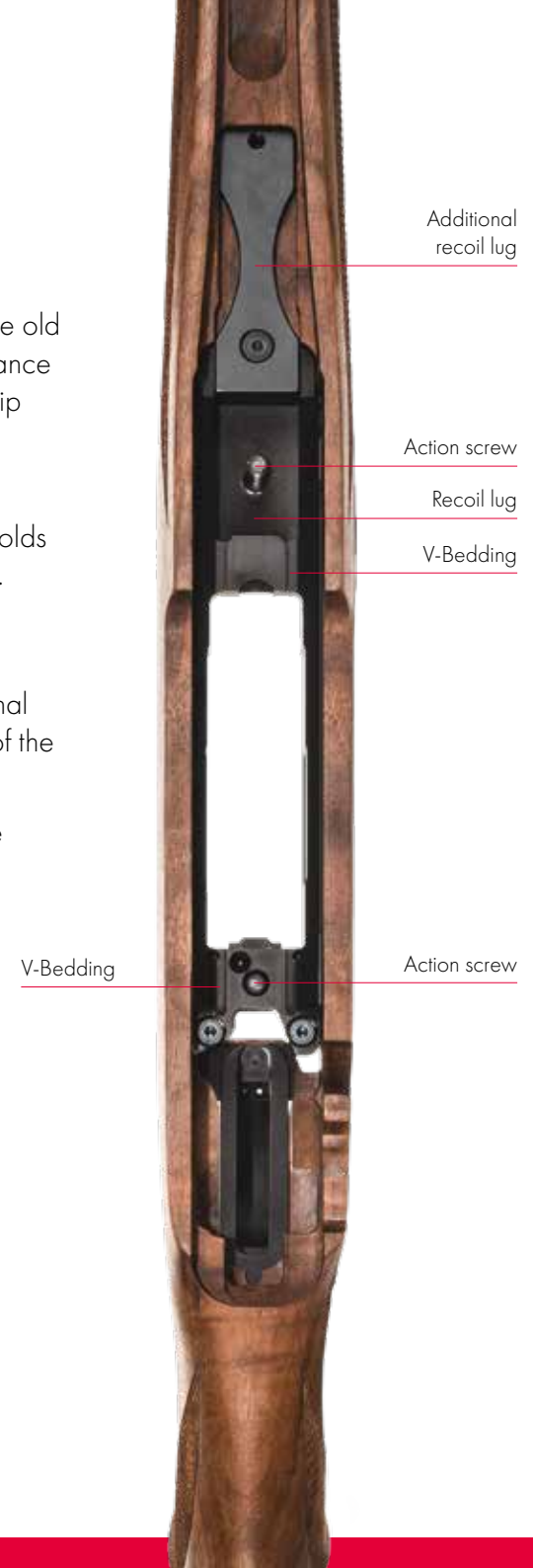





ANSCHÜTZ

EINFACH EINS WERDEN!

1771

*UNCOMPROMISING
THE BEST FOR TWO WORLDS*

**.17 Hornet | .22 Hornet
.222 Rem. | .223 Rem.**



In our world where digital is the main thing, craftsmanship and experience almost seem to be outdated. ANSCHÜTZ guarantees to be always **uncompromisingly traditional** – but still act with the trend of the **modern world**! Ideas are our "software"; experience is carrying us into the future. Values are associated with purpose; we're experts in producing excellent firearms for exacting shooters. So you can proudly say:

My ANSCHÜTZ

1771

HIGH-TECH MASTERPIECE!

OK. We recognize that calling the 1771 a "high-tech masterpiece" sounds a lot like marketing speak and like we're promoting something. But how else could we describe a rifle that

- hits the target with fantastic precision;
- has an incredibly soft and extremely quick-to-repeat bolt movement;
- works reliably in all wind and weather conditions;
- is the ideal rifle for both hunting and target shooting: Additionally, it's also perfect for training in hunting schools and for use as a training firearm or in a shooting simulator!

So we thought all over that again, before finally realizing: That's right, it's really a "masterpiece". But we like also calling it simply: the **ANSCHÜTZ 1771!**

1771 GERMAN STOCK

BALANCED, AESTHETIC AND TIMELESS

Made from walnut from age-old forests, visually and functionally refined with a non-slip checkering. Hard and deformation-resistant, natural and individual. No stock is the same as any other. The rubber butt pad absorbs the recoil and holds the rifle securely in the shoulder when aiming.



German style stock with bavarian cheek piece.



Thumbhole stock with ergonomically shaped roll-over cheek piece and generously designed grip area.

ANSCHÜTZ

EINFACH EINS WERDEN!

- 1 Slip resistant rubber butt pad
- 2 German style stock, made of oiled walnut
- 3 Bolt handle lock
- 4 Sliding safety catch
- 5 Fine-ground bolt with locking lugs
- 6 Picatinny rail, assembled in the factory
- 7 ANSCHÜTZ Precision barrel
- 8 Barrel thread M15x1
- 9 Studs
- 10 Non-slip checkering
- 11 Single stage trigger 5097/2D, 1.000 - 1.700 g, factory set at 1.200 g
- 12 Magazine release lever
- 13 Magazine easy to exchange, made of stainless steel
- 14 Ergonomic thumbhole stock, made of beautiful grown walnut
- 15 Steep pistol grip with non-slip checkering
- 16 Match two stage trigger 5098/71, 250 - 450 g, factory set at 300 g



Shown: Model 1771 German stock, caliber .223 Rem., 586 mm barrel and M15x1 barrel thread.



Shown: Model 1771 Thumbhole stock, caliber .17 Hornet, 510 mm barrel and barrel thread M15x1.

1771 THUMBHOLE STOCK

A SYMBIOSIS OF STYLE AND FUNCTION

A futuristic design that incorporates the attributes of a classic. Quiet and precise stop. The trigger finger remains strain-free and movable; it doesn't have to support anything. As for the carefully selected and mature walnut wood: a gentle oil bath gives the stock its matt appearance and protects it from the elements.

1771 MODELS PRODUCT INFORMATION

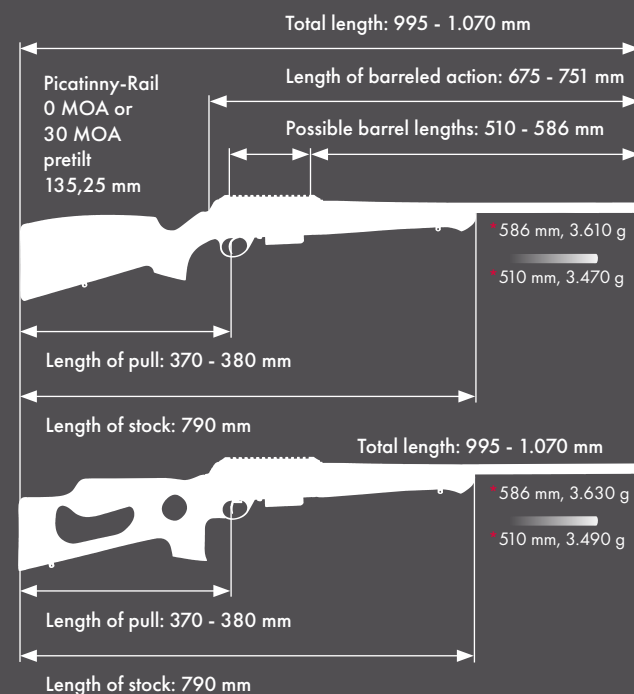

Total weight, depending on barrel length: 3.470 - 3.630 g



Single stage trigger 5097/2D: factory set at 1.200 g adjustable from 1.000 - 1.700 g



Single stage trigger 5097/2D Tuning: factory set at 500 g adjustable from 450 - 650 g



Two stage trigger 5098/71: factory set at 300 g adjustable from 250 - 450 g

Scope of delivery:

Model 1771 configurations are delivered, depending on the desired configuration, with 3, 4 or 5-shot magazine (.17 Hornet 5-shot, .22 Hornet 3-shot, .222 Rem./ .223 Rem. 4-shot), sling swivel, transport rifle case MEGA Version II (length 118 cm) and original test target and quality control card.

1771 GRS SPORTER

DETAILS WITH THE POWER OF DIFFERENCE

An exceptional stock, built in Norway. Ergonomics to perfection. Equipped with details that let you hit even safer. Adjustable butt plate for shooting from standing, kneeling, lying down. Vertically adjustable cheek piece for a relaxed neck. Transition zone between sport and hunting: It fulfills the needs of both areas.

The cheek piece and butt plate can be adjusted quickly and easily with the SpeedLock 2.0 system, depending on the aiming and shooting position.



Precisely adjustable cheek piece for the best possible shot in all hunting situations and for competitive shooting.

- 1 Slip resistant rubber butt pad, adjustable in length
- 2 SpeedLock 2.0 system (push button) for adjusting the butt plate
- 3 Height-adjustable cheek piece for a relaxed head position. The cheek piece can be tilted sideways in 5° steps.
- 4 SpeedLock 2.0 system (push button) for adjusting the cheek piece
- 5 GRS Sporter stock with ergonomic grip area
- 6 Bolt handle lock
- 7 Sliding safety catch
- 8 Fine-ground bolt with locking lugs
- 9 Picatinny rail, assembled in the factory
- 10 ANSCHÜTZ Precision barrel
- 11 Barrel thread M15x1
- 12 Trigger guard, protects the trigger
- 13 Match two stage trigger 5098/71, 250 - 450 g, factory set at 300 g
- 14 Magazine release lever
- 15 Magazine easy to exchange, made of stainless steel
- 16 Studs
- 17 Cheek piece, adjustable in height
- 18 DJV-Stock, made of beautiful grown walnut
- 19 Non-slip checkering
- 20 Match two stage trigger 5098/71, 250 - 450 g, factory set at 300 g
- 21 Magazine release lever, integrated in the stock
- 22 Magazine easy to exchange, made of stainless steel, ends flat with the stock



Shown: Model 1771 GRS Sporter, caliber .223 Rem., 586 mm barrel and barrel thread M15x1.

Available as an accessory: The barrel weight with 365 g and 116 mm length ensures optimum balance and comfortable swinging in disciplines such as "running boar". The barrel weight is mounted "overbarrel" and therefore does not extend the overall length.



Shown: Model 1771 DJV, caliber .22 Hornet, 510 mm barrel and barrel thread M15x1.

1771 DJV-STOCK AT THE FRONTIER OF HUNTING AND SPORT

Made from beautifully grown walnut wood with the finest oil finish, the stock is specially developed for competitive hunting style shooting. The adjustable cheek piece reduces head tilt and relaxes the neck muscles. The special DJV magazine ends flat with the stock. The fore-end can be hold without annoying elements.

1771 MODELS PRODUCT INFORMATION

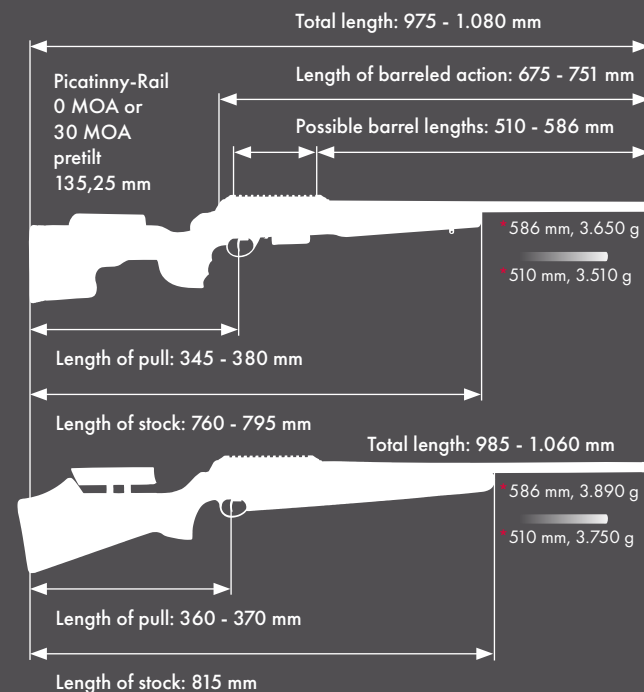

Total weight, depending on barrel length:



Single stage trigger 5097/2D: factory set at 1.200 g adjustable from 1.000 - 1.700 g



Single stage trigger 5097/2D Tuning: factory set at 500 g adjustable from 450 - 650 g



.17 Hornet



.22 Hornet



.222 Rem.



.223 Rem.



Two stage trigger 5098/71: factory set at 300 g adjustable from 250 - 450 g

Scope of delivery:

Model 1771 configurations are delivered, depending on the desired configuration, with 3, 4 or 5-shot magazine (.17 Hornet 5-shot, .22 Hornet 3-shot, .222 Rem./ .223 Rem. 4-shot), sling swivel, transport rifle case MEGA Version II (length 118 cm) and original test target and quality control card.

1771 CONFIGURATOR

ACCORDING TO YOUR WISHES!

Technical data (depending on the configuration):

The total weight is between 3.470 g and 3.940 g.
The total length is between 975 mm and 1.181 mm.

For detailed information, please refer to the "Product information" section highlighted in gray on the previous product pages.

1. STOCK



German stock - Right hand version
Length of pull 370 mm
Material.....Walnut, oiled
Wood grades (S) (P) (L) (M)



DJV stock - Right hand version
Length of pull 360 mm
Material.....Walnut, oiled
Wood grades (S) (P)



Thumbhole stock - Right hand version
Length of pull 370 mm
Material.....Walnut, oiled
Wood grades (S) (P)



GRS Sporter - Right hand version
Length of pull 345 - 380 mm
Material.....Walnut, oiled

2. CALIBER

.17 Hornet

Number of grooves 6
Twist rate..... 9"/228 mm
Magazine capacity 5 Shot



.22 Hornet

Number of grooves 6
Twist rate..... 16"/400 mm
Magazine capacity 3 Shot



.222 Rem.

Number of grooves 6
Twist rate..... 14"/356 mm
Magazine capacity 4 Shot



.223 Rem.

Number of grooves 6
Twist rate..... 9"/229 mm
Magazine capacity 4 Shot



Scope of delivery:

Your rifle-configuration, incl. transport rifle case MEGA Version II (length 118 cm), the original test target and quality control card and a set of sling swivels 1". (Configurations in DJV stock are supplied without sling swivel).



3. BARREL LENGTH

510 mm (20 Inch) Barrel

Length of barreled action675 mm

Muzzle diameter 18 mm



586 mm (23 Inch) Barrel

Length of barreled action751 mm

Muzzle diameter 18 mm



4. MUZZLE OPTION

Recessed muzzle

High-precision manufactured muzzle that is slightly recessed in the center.



Barrel thread M15x1 with thread protector

The barrel thread allows you to quickly and easily assemble a sound moderator or a muzzle brake.



5. TRIGGER



Single stage trigger 5097/2 D

Factory set at1.200 g

Adjustment range...1.000 g - 1.700g



Single stage trigger 5097/2 D Tuning

Factory set at500g

Adjustment range...450g - 650g

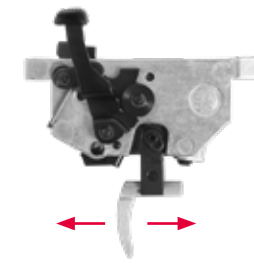

Two stage trigger 5098/71

Factory set at300g

Adjustment range...250g - 450g

Adjustment of the trigger blade....17,7 mm



1771 CONFIGURATOR

ACCORDING TO YOUR WISHES!

6. MAGAZINE



1771 Magazine, Standard

Made of stainless steel, different number of shots depending on caliber.

Cal. .17 Hornet - 5 shots

Cal. .22 Hornet - 3 shots

Cal. .222 Rem./ .223 Rem. - 4 shots

If the DJV stock is selected, the DJV magazine is supplied with a long magazine base.

7. WOOD GRADES

Wood grade Standard (S)*



Wood grade Premium (P)*



Wood grade Luxus (L)*



Wood grade Meistergrade (L)*



*All wood grades shown are only examples. Wood is a natural product. Deviations in grain, wood structure and color within the ANSCHÜTZ wood quality grades are possible. The availability of the wood grades depends on the respective stock design. Further information at www.anschuetz-sport.com

8. PICATINNY RAIL



1771 Picatinny rail

Made of high-strength aluminum, with 0 MOA pretilt. Assembled in the factory



1771 Picatinny-Schiene

Made of high-strength aluminum, with 30 MOA pretilt. Assembled in the factory.

9. BOLT KNOB



Standard

Made of high strength synthetic, 25 mm diameter, black.



Walnut

Made of walnut wood, 20 mm diameter.



Black Line

Deep black, DLC (Diamond Like Carbon) coated, 25 mm diameter.



Checkering and silver lines

With knurled checkering and elegant, timeless silver lines, 25 mm diameter.



Silver lines

With elegant, timeless silver lines, 25 mm diameter.



Checkering

With knurled checkering, timelessly elegant in black, 25 mm diameter.



Walnut

Made of walnut wood, 25 mm diameter.



Steel

Made of blued steel, 25 mm diameter.



Gold star

With knurled checkering, gold lines and elegant gold star, 25 mm diameter.



Checkering and gold lines

With knurled checkering and elegant, timeless gold lines, 25 mm diameter.



Gold lines

with elegant, timeless gold lines, 25 mm diameter.



APR

For fast repeating, with non-slip grooves, made of high-strength aluminum. Length 40 mm, Ø 22 mm.



10. BARREL THREAD



Standard

For barrel thread M15x1, made of blued steel with knurled checkering.



Silver lines

For barrel thread M15x1, made of blued steel with an elegant and timeless silver lines and knurled checkering.



Gold lines

For barrel thread M15x1, made of blued steel with an elegant and timeless gold lines and knurled checkering.



**OPTIONAL ACCESSORIES (TO BE ORDERED SEPARATELY)
FURTHER ACCESSORIES FROM PAGE 83.**



1771 Barrel weight 365 g

For optimizing the balance, for model 1771 with thread M15x1.

Item No.: 014684



ANSCHÜTZ Caps

Made of robust fabric that is ideal for hunting and all outdoor activities. The size of the cap can be adjusted. With an elegant ANSCHÜTZ leather patch.

Item No.: 011690 (brown)

Item No.: 015805 (green)



ANSCHÜTZ Special soft case for hunting and sporting rifles

As a special feature, the new carrying strap system, including a lock, also lets you carry the soft case on your back. Outer dimensions: 1.250 x 250 x 50 mm

Item No.: 015504



Almost a new type of firearm:
the perfect choice for **roe deer** and
small game hunting grounds and,
at the same time, ideal for **target**
shooting and **training**.

**A Hunting rifle for
(almost) everything!**

1771

EXCEPTIONALLY INDIVIDUAL

Stock and barrel, bolt and trigger, receiver and cartridge – you might think a rifle is, in itself, quite a simple product.

Far from it!

The trigger of the 1771 alone is made up of numerous components! It comes in three versions. Four stocks, two barrel lengths ... the choice of caliber increases the range of configurations considerably.

Combine your requirements, then you'll end up holding a rifle that's been configured so it's virtually one-of-a-kind.

The ANSCHÜTZ 1771.

1771 ACTION

A COMPACT STATEMENT

The lightweight receiver is robust and resistant. Incorporated immovably in the stock for outstanding shooting performance. Sturdy and resistant to heat and cold. With a matt-finished appearance that's timelessly elegant. Equipped with a Picatinny rail - assembled in factory - to make it flexible and versatile. Gas vent holes are an inconspicuous but important detail for your safety.

1771 BOLT

SAFETY FIRST!

Complete without a gap, for maximum safety: Depending on the caliber single-row or two-row three-locking lug. A reliable and durable element.



1771 MAGAZINE STRONG RESERVE

Extremely comfortable to handle! The magazine holds three, four or five cartridges (depending on the caliber), is made from sturdy stainless steel and is thus insensitive to dust, dirt and water.



Recessed muzzle or barrel thread M15 x 1 with thread protector

Magazine made from stainless steel



DJV magazine with extended magazine base



1771 TRIGGER A MASTER STROKE

Precision proven many times over from high-performance sports – in summer and in winter. Depending on the trigger, very wide adjustment range of the trigger weight. Ergonomic and silently operated safety catch.

The location in the rifle with the decisive moment: High-precision parts in harmony in the tightest of spaces for a single task – creating the perfect "interface". The interface between human and rifle. Near to unique, and meanwhile adapted by other manufacturers.

There is nothing better.



High-precision manufactured and lapped individual parts

Single stage trigger 5097/2D Tuning

Two stage trigger 5098/71

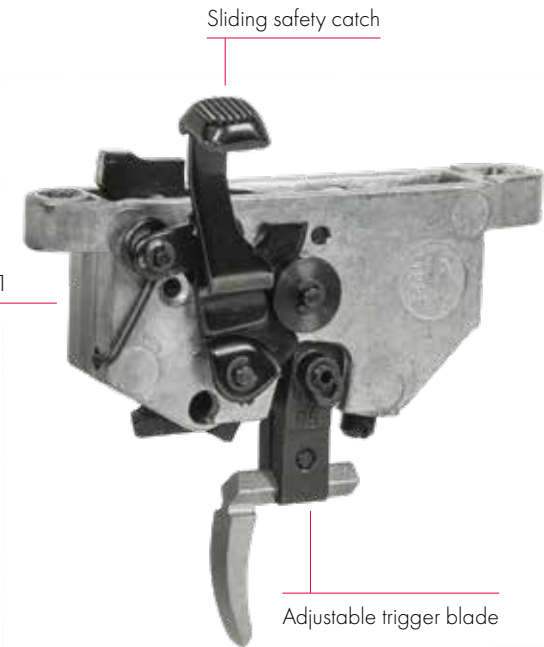

Sliding safety catch

Adjustable trigger blade

Three different triggers can be chosen:

- 5098/71 – Match two stage trigger, adjustable from 250 g - 450 g
- 5097/2D Tuning – Match single stage trigger, adjustable from 450 g - 600 g
- 5097/2D – Match single stage trigger, adjustable from 1.000 g - 1.700 g



The background of the advertisement is a blurred forest scene. On the left side, the barrel and wooden stock of an Anschutz 1761 rifle are visible, extending horizontally across the frame. The rifle is held by a hand resting on a weathered wooden post. The overall aesthetic is one of precision and craftsmanship in a natural setting.

ANSCHÜTZ

EINFACH EINS WERDEN!

1761

*THE SYNTHESIS OF HIGH TECHNOLOGY
AND CRAFTSMANSHIP*

.17 HMR | .22 l.r. | .22 WMR



Since 1856, over the course of six generations, we have paired available knowledge with newly-obtained scientific understanding. We generate **trust**, we generate **reliability**, we generate **precision**. All of this, so you can stand up proudly and say:

My ANSCHÜTZ

1761

THE FIRST SHOT

You pick it up, and at once you feel:

This small-bore rifle is something else!

At this moment, you probably won't think immediately about the gunsmith in his studio and about the time spent in **polishing metal components**; maybe you don't know anything about the care with which the technician **lapped** and **honed** the barrel, but the matte surface, the perfectly soft gliding head of the bolt, and the **closed** connection of the stock and framework formed by the hidden thrust bearing will captivate you.

You will likely not even feel the small bearing, the four millimeters of steel support in the interior of the bolt, in which the three-lug locking mechanism ensures a self-centring closure in the action, but you will certainly notice the smooth repeating speed of the 1761.

The way you become one with the 1761 will trigger a smile: My rifle!

You won't want to put it down.

1761 THUMBHOLE STOCK

THE COMPLEX MADE SIMPLE – PRECISION IN PERFECTION

The thumbhole stock. The eye-catcher when it comes to optical and functional advantages. Light walnut, oiled with satin finish; the trigger finger is free to act without being burdened. The milled recesses lend the 1761 in the thumbhole stock a futuristic look, which will maintain its good appearance for many years to come!



Thumbhole stock with ergonomically shaped roll-over cheek piece.



Optional 1761 Picatinny rail with 0 or 30 MOA pretilt available



Model 1761 Classic can be configured as a right-hand or left-hand version, **at no extra charge!**

- 1 Non-slip rubber butt pad
- 2 Ergonomic walnut thumbhole stock, oiled with satin finish
- 3 Integrated groove for optic recoil lug
- 4 Sliding safety catch
- 5 11 mm-ANSCHÜTZ prism rail
- 6 Interchangeable ANSCHÜTZ precision barrel
- 7 Barrel thread 1/2"-20 UNF
- 8 Single stage trigger 5061 D Heavy 800 - 1.600 g, factory set at 1.000 g

- 9 Classic ambidextrous walnut stock, oiled with satin finish
- 10 Studs
- 11 Non-slip checkering in new design
- 12 Trigger guard made of high strength molded polymer
- 13 Match two stage trigger 5061 Heavy 800 - 1.600 g, factory set at 1.000 g
- 14 Magazine release lever
- 15 5-shot magazine, easy to exchange



Shown: Model 1761 thumbhole stock, caliber .22 WMR, 515 mm barrel and barrel thread 1/2"-20 UNF, single stage trigger 5061 D Heavy



Shown: Model 1761 Classic, caliber .22 l.r., 457 mm barrel and barrel thread 1/2"-20 UNF, two stage trigger 5061 Heavy

1761 CLASSIC WELL-BALANCED

The well balanced and ambidextrous oiled walnut stock. Looks traditional – looks good. For the right-handed shooter, for the left-handed shooter. Straight-forward, effective, low in vibration, well-balanced. Laser-cut, weather-resistant checkering for optimal grip. Shock-absorbing, non-slip rubber butt pad.

1761 MODELS PRODUCT INFORMATION

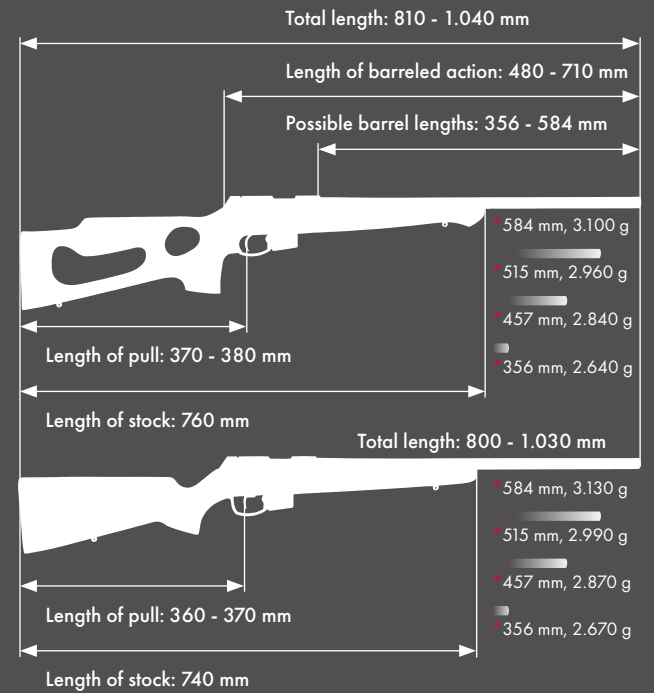

- Total weight, depending on barrel length: 2.640 - 3.130 g
- Single stage trigger 5061 D Heavy factory set at 1.000 g adjustable from 800 - 1.600 g
- Single stage trigger 5061 D Light factory set at 300 g adjustable from 250 - 500 g
- Two stage trigger 5061 Heavy factory set at 1.000 g adjustable from 800 - 1.600 g
- Two stage trigger 5061 Light factory set at 300 g adjustable from 250 - 500 g



Important: Barrel lengths depend on caliber, not all lengths are possible for all calibers. For more information see page 54-55.

Scope of delivery:

Model 1761 configurations are delivered depending on the desired configuration with original test target and quality control card.

1761 MONTE CARLO

ELEGANT AND ERGONOMIC

Matt oiled walnut stock with schnabel tip, pistol grip and grippy, finely cut checkering for secure grip even in wet conditions. The roll-over cheek piece offers a perfect and comfortable position of your head when aiming. The configuration shown is equipped with the high-contrast open sight, which obscures very little of the target and therefore allows quick target acquisition. Ideal for quick shots at medium distances without a telescopic sight. The rear sight with three inlaid, yellow illuminated aiming points can be adjusted laterally and in height. The red front sight is protected by the front sight guard and forms a strong contrast - even in poor lighting conditions.



Monte Carlo stock with ergonomically shaped roll-over cheek piece.



Optional 1761 Picatinny rail with 0 or 30 MOA pre-tilt available



High-contrast open sight with aiming points.

- 1 Non-slip rubber butt pad
- 2 Ergonomic Monte Carlo stock made of beautiful grown oiled walnut with roll-over cheek piece
- 3 Integrated groove for optic recoil lug
- 4 Sliding safety catch
- 5 11 mm-ANSCHÜTZ prism rail
- 6 Rear sight with three inlaid yellow luminous dots
- 7 Interchangeable ANSCHÜTZ precision barrel
- 8 Red pearl front sight out of polymer with protection hood, adjustable in height
- 9 Inner thread M12x1
- 10 Match two stage trigger 5061 Light, 250 - 500 g, factory set at 300 g
- 11 Classic ambidextrous walnut stock, oiled with satin finish
- 12 Studs
- 13 Non-slip checkering in new design
- 14 Trigger guard made of high strength molded polymer
- 15 Match two stage trigger 5061 Heavy 800 - 1.600 g, factory set at 1.000 g
- 16 Magazine release lever
- 17 Detachable 5-shot magazine, easy to exchange
- 18 Barrel with integrated sound moderator

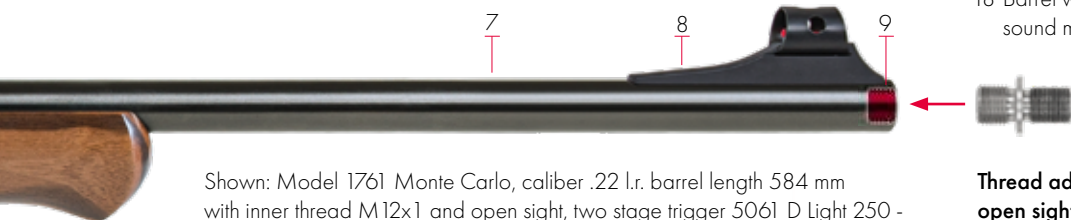

Shown: Model 1761 Monte Carlo, caliber .22 l.r. barrel length 584 mm with inner thread M12x1 and open sight, two stage trigger 5061 D Light 250 - 500 g, shown with higher quality wood grade.

Thread adapter for 1761 barrels with open sight and inner thread

From inner thread M12x1 to external thread 1/2" - 20 UNF. Optionally available as an accessory.

Model 1761 Whisper, caliber .22 l.r.

Barrel length 365 mm, single stage trigger 5061 D Heavy 800 - 1.200 g, total length 935 mm, total weight approx 3.150 g
Item No.: 015279 (Right hand version)



1761 WHISPER – ONLY AVAILABLE IN .22 l.r. SILENT TRUST

Whispering, quiet and silent. Stainless steel, accuracy craftsmanship, easy handling. Radiate silence, convinces all along the line. With low noise, highest precision and with little damage to the game or pelt, this rifle is well suited for urban areas.

1761 MODELS PRODUCT INFORMATION

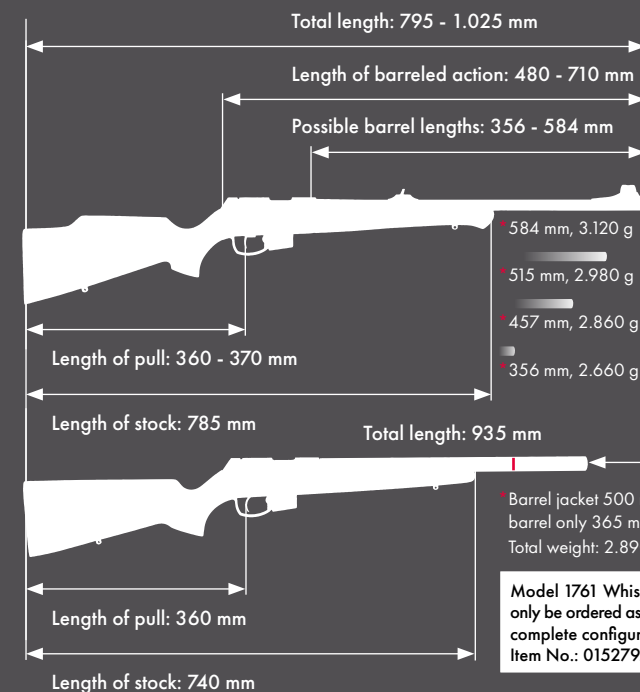



Model 1761 Whisper can only be ordered as .22 l.r. complete configuration Item No.: 015279.

 Total weight, depending on barrel length: 2.660 - 3.120 g



Important: Barrel lengths depend on caliber, not all lengths are possible for all calibers. For more information see page 54-55.

 Single stage trigger 5061 D Heavy factory set at 1.000 g adjustable from 800 - 1.600 g

 Single stage trigger 5061 D Light factory set at 300 g adjustable from 250 - 500 g

 Two stage trigger 5061 Heavy factory set at 1.000 g adjustable from 800 - 1.600 g

 Two stage trigger 5061 Light factory set at 300 g adjustable from 250 - 500 g

Scope of delivery:

Model 1761 configurations are delivered depending on the desired configuration with original test target and quality control card.

1761 CONFIGURATOR - HUNTING MODELS ACCORDING TO YOUR WISHES!

Technical data (depending on the configuration):

The total weight is between 2.640g and 3.070 g.
The total length is between 795 mm and 1.035 mm.

For detailed information, please refer to the „Product information“ section highlighted in gray on the previous product pages.

1. STOCK



Also available as a left-hand version at no extra charge



Classic - Right or left hand version

Length of pull360 mm

Material.....Walnut, oiled

Wood grades (S) (P) (L) (M)



Monte Carlo - Right hand version

Length of pull360 mm

Material.....Walnut, oiled

Wood grades (S) (P)



Thumbhole stock - Right hand version

Length of pull370 mm

Material.....Walnut, oiled

Wood grades (S) (P)

2. CALIBER

Caliber .17 HMR

Number of grooves 6

Twist rate..... 9"/228 mm



Caliber .22 I.r.

Number of grooves 8

Twist rate..... 17"/420 mm



Caliber .22 WMR

Number of grooves 8

Twist rate..... 16"/395 mm



Scope of delivery:

Your rifle configuration with original test target and quality control card.



3. BARREL LENGTH

356 mm (14 Inch) Barrel

Length of barreled action480 mm

Muzzle diameter 19 mm



457 mm (18 Inch) Barrel

Length of barreled action580 mm

Muzzle diameter 19 mm



515 mm (20.3 Inch) Barrel

Length of barreled action645 mm

Muzzle diameter 19 mm



584 mm (23 Inch) Barrel

Length of barreled action715 mm

Muzzle diameter 19 mm



584 mm barrel only with caliber .22 l.r.

4. MUZZLE OPTION

Recessed muzzle



Barrel thread ½ Zoll - 20 UNF with thread protector



Barrel thread ½ Zoll - 28 UNEF with thread protector



Open sight with inner barrel thread M12x1 (+20 g)



Open sight only with cal. .22 l.r. and barrel length 515 and 584 mm

5. TRIGGER



Single stage trigger 5061 D Light

Factory set at300 g

Adjustment range.....250 g - 500 g



Single stage trigger 5061 D Heavy

Factory set at1.000 g

Adjustment range.....800 g - 1.600 g



Two stage trigger 5061 Light

Factory set at300 g

Adjustment range.....250 g - 500 g



Two stage trigger 5061 Heavy

Factory set at1.000 g

Adjustment range.....800 g - 1.600 g



1761 CONFIGURATOR - HUNTING MODELS ACCORDING TO YOUR WISHES!

6. MAGAZINE



1761 Magazine, Standard

5-shot magazine made of stainless steel with high-strength synthetic magazine base.



For
caliber
.22 l.r.
only

1761 Magazine, 10-Shot, cal. .22 l.r.

10-shot magazine made of stainless steel with high-strength synthetic magazine base.

7. WOOD GRADES

Wood grade Standard (S)*



Wood grade Premium (P)*



Wood grade Luxus (L)*



Wood grade Meistergrade (M)*



*All wood grades shown are only examples. Wood is a natural product. Deviations in grain, wood structure and color within the ANSCHÜTZ wood quality grades are possible. The availability of the wood grades depends on the respective stock design. Further information at www.anschuetz-sport.com

8. MOUNTING PLATFORM



1761 Prism rail

11 mm prism rail, milled directly into the receiver, with integrated recoil lug. Included with every configuration.



0 MOA

1761 Picatinny rail 0 MOA

Made of high-strength aluminum, with 0 MOA pretilt. Assembled on the prism rail at the factory.



30 MOA

1761 Picatinny rail 30 MOA

Made of high-strength aluminum, with 30 MOA pretilt. Assembled on the prism rail at the factory.

9. TRIGGER GUARD



1761 Trigger guard, standard

Made of high-strength synthetic material, comfortable to hold at any temperature.



1761 Trigger guard, aluminum

Made from high-strength aluminum. Elegantly shaped, a high-quality extra for eternity.

10. BOLT KNOB



Standard
Made of high strength synthetic, 25 mm diameter, black.



Walnut
Made of walnut wood, 25 mm diameter.



Walnut
Made of walnut wood, 20 mm diameter.



Steel
Made of blued steel, 25 mm diameter.



Black Line
Deep black, DLC (Diamond Like Carbon) coated, 25 mm diameter.



Gold star
With knurled checkering, gold lines and elegant gold star, 25 mm diameter.



Checkering and silver lines
With knurled checkering and elegant, timeless silver lines, 25 mm diameter.



Checkering and gold lines
With knurled checkering and elegant, timeless gold lines, 25 mm diameter.



Silver lines
With elegant, timeless silver lines, 25 mm diameter.



Gold lines
with elegant, timeless gold lines, 25 mm diameter.



Checkering
With knurled checkering, timelessly elegant in black, 25 mm diameter.



APR
For fast repeating, with non-slip grooves, made of high-strength aluminum. Length 40 mm, Ø 22 mm.

OPTIONAL ACCESSORIES (TO BE ORDERED SEPARATELY) FURTHER ACCESSORIES FROM PAGE 83.



1761 Cleaning rod guide
The cleaning rod guide protects the cartridge chamber and the trigger unit from scratches, cleaning agents and residues from the barrel.
Item No.: 015655



1761 Magazine loading help
Enables easy and quick loading of the magazine.
Item No.: 015298



ANSCHÜTZ Special soft case for hunting and sporting rifles
As a special feature, the new carrying strap system, including a lock, also lets you carry the soft case on your back. Outer dimensions: 1.250 x 250 x 50 mm
Item No.: 015504

1761 MP R MULTI PURPOSE BEAVERTAIL, CAL. .22 L.R.

FLEXIBLE FOR HIGHEST PRECISION

Developed from the needs of shooters from the range and the field, this stock combines the advantages of a classic target stock, combined with the wide and easy to handle beavertail forend. The integrated aluminum rail in the forend makes this stock a great overall package. Stained walnut with stippled checkering at pistol grip, prepared for attaching a butt plate carrier and can therefore be flexibly adjusted in length.



MP R and MS R stocks are prepared for the installation of a clamp piece to mount a butt plate carrier.



Optional 1761 Picatinny rail with 0 or 30 MOA pre-tilt available

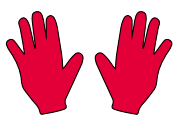

Model 1761 MP R can be configured as a right-hand or left-hand version, **at no extra charge!**

- 1 Non-slip rubber butt pad
- 2 Prepared for attaching a butt plate carrier
- 3 Stained Multi Purpose Beavertail stock made of beautiful grown hardwood
- 4 Stippled checkering
- 5 Integrated groove for optic recoil lug
- 6 Sliding safety catch
- 7 11mm-ANSCHÜTZ prism rail
- 8 Heavy ANSCHÜTZ precision barrel

- 9 Reinforced, recessed muzzle with groove for attaching a front sight
- 10 Match two stage trigger 5061 Light, 250 g - 500 g
- 11 Wide and easy to handle beavertail forend with integrated aluminum rail for accessories
- 12 Lacquered stock made of beautiful grown walnut with stippled checkering
- 13 Ergonomic grip with stippled checkering

- 14 Trigger guard made of high strength synthetic
- 15 Match two stage trigger 5061 Light, 250 g - 500 g
- 16 Magazine release lever
- 17 Detachable 5-shot magazine, easy to exchange
- 18 Grip and forend with stippled checkering and integrated aluminum rail for accessories



Model 1761 MP R, caliber .22 l.r.
 Heavy barrel, barrel length 544 mm,
 two stage trigger 5061 D Light 250 - 500 g,
 rubber butt pad
 Item No.: 015539



Reinforced, recessed muzzle
 with groove for attaching a front sight.



Model 1761 MS R, caliber .22 l.r.
 Heavy barrel, barrel length 544 mm,
 two stage trigger 5061 D Light 250 - 500 g,
 rubber butt pad
 Item No.: 015540

1761 MS R, CAL. .22 L.R THE SPORTING RIFLE

The ANSCHÜTZ small bore rifle for shooting on metal silhouettes and targets. Receiver with an 11 mm ANSCHÜTZ prism rail and grooved barrel for attaching a front sight, so you can also shoot with sight set. Anatomically designed stock with cheek piece especially made for these disciplines. With non-slip and adjustable rubber butt plate and aluminum rail in the forend. The stock is prepared for the assembly of a butt plate carrier – to adjust the stock in length. Stippled checkering on pistol grip and forend.

1761 MODELS PRODUCT INFORMATION

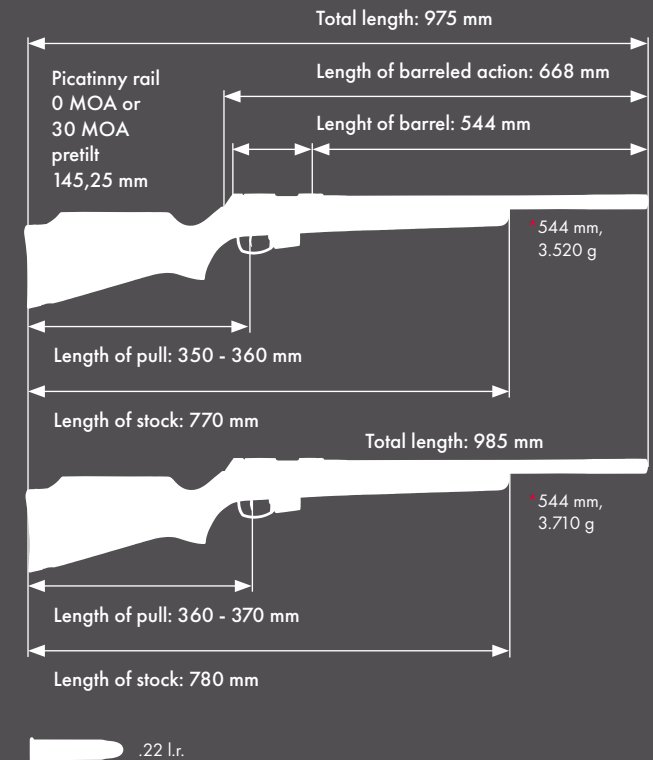

.22 l.r.



Total weight,
 depending on
 model:
 3.520 - 3.710 g



Two stage trigger 5061 Light
 factory set at 300 g
 adjustable from 250 - 500 g

Item numbers:

- 1761 MPR 544 mm barrelItem No.: 015539
- 1761 MSR 544 mm barrelItem No.: 015540

Scope of delivery:

Model 1761 MPR or 1761 MSR are supplied with a 5-shot magazine, transport rifle case Mega Version II (length 118 cm) and original test target and quality control card.



You can always rely on an ANSCHÜTZ hunting bolt action rifle. Your ANSCHÜTZ rifle will be a reliable companion for you at all times, with unsurpassed precision and functionality. This is what the name ANSCHÜTZ stands for.

ANSCHÜTZ 1761

1761

FIND REPOSE

Shooting is a complex, contradictory act, but ultimately, in the core of its being, it forces the shooter to re-examine himself.

LOOK INWARD – BREATHE – STAY STILL – FEEL – CONCENTRATE ... the actual triggering of the shot is almost of secondary importance.

On the following pages, you will experience the 1761 in its full range of detail. You will see the interplay of cleverly devised components produced with devotion and tested with meticulous attention to detail.

The ANSCHÜTZ 1761.

1761 ACTION

EVERYTHING THAT MAKES A ANSCHÜTZ.

The foundation of our high precision rests on the barreled action design. Geometry inspired by our target rifles, with a high degree of stiffness, a flat supporting surface and an integrated recoil lug. The precision action is manufactured by highly demanding production processes and with gunsmiths expertise.

In the action integrated well engineered ejector can be changed very easily.

The luminous matte surface lends the model 1761 a timeless appearance, which will continue to look excellent even for many years to come.



1761 BOLT RUNS EASY AND QUICK

The small bearing reduces the force needed to open and to close the bolt. Fast and easy repeats are possible. Symmetrically arranged three-lug locking mechanism for the highest safety and phenomenal precision. Simple disassembly for care and cleaning. The high-quality and resistant QPQ coating ensures additional sliding capacity, resistance to wear, and corrosion protection, and thus is perfect for use in hunting and for harsh weather conditions.



1761 TRIGGER OUR TRADITION

It doesn't matter which kind of trigger you need, whether single stage or two stage, which aiming position is preferred or required, whether prone, sitting, kneeling or freehand standing:

With different triggers for the model 1761, you will find the perfect interface between you and your 1761 small bore rifle.

There is nothing better.

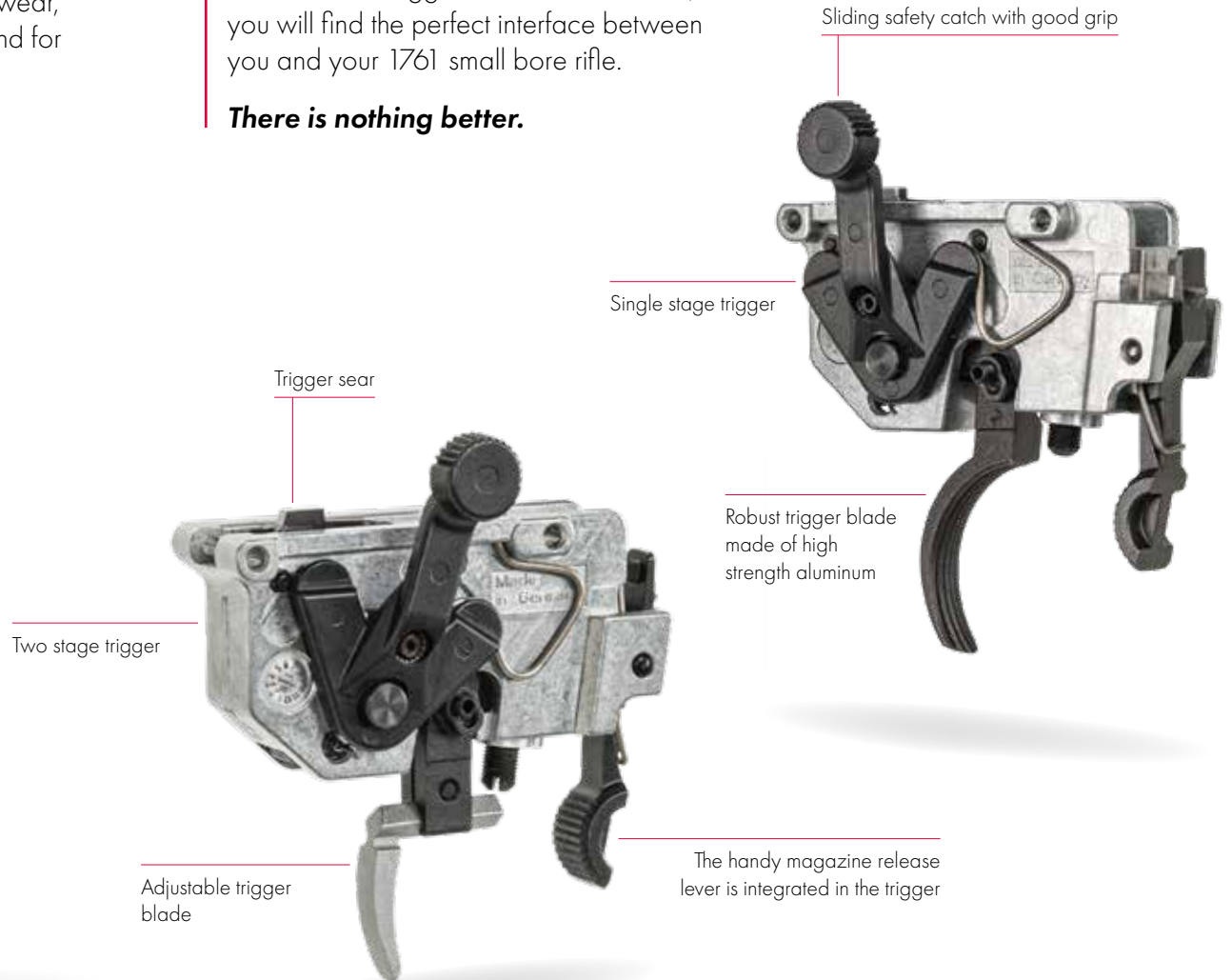

1761 BARREL VERSIONS

EXPERIENCE LEADS TO PRECISION

The 1761 modular system offers the perfect barrel versions for every application. If you need a heavy precision barrel or classic hunting barrels in different lengths - we have what you looking for.

Following barrel versions for your perfect configuration:

- Heavy precision barrel, 21.4" (544 mm) grooved, with reinforced muzzle
- Precision hunting barrels in different lengths
23" (584 mm)
20.3" (515 mm)
18" (457 mm)
14" (356 mm)
- Two different muzzle threads $\frac{1}{2}$ " - 20 UNF and $\frac{1}{2}$ " - 28 UNEF
- Hunting barrel with open sight (FL)
20.3" (515 mm) or 23" (584 mm) with inner thread M12x1
- Barrel with integrated sound moderator (only .22 l.r.)
19.3" (492 mm), the integrated sound moderator is easy to disassemble and to clean

If you would like to change the caliber, the barrel can be easily altered by a qualified gunsmith. Thanks to its two tenon locking clamps, the barrel clamping allows for the barrel to be re-inserted with perfect precision - every time.



1761 OPTICS AND ASSEMBLY

THE LINK

The 11 mm ANSCHÜTZ prism rail integrated in the receiver enables the flexible mounting of a wide variety of optics. The integrated support in the prism rail offers maximum stability and repeatability when mounting our optional 1761 Picatinny rail with 0 or 30 MOA pretilt.



10-Shot,
caliber .22 l.r.
only

1761 MAGAZINE

STRONG HANDLING

The single-stack 5 or 10-shot magazine with a robust stainless steel housing can be changed extremely quick and easy. This is made possible by the release lever integrated into the trigger and the extended magazine base plate. The high-strength magazine base plate is made of weather-resistant polymer.



5-Shot

1761 STOCK AND ACTION BEDDING **THE BASE OF PRECISION**

The oiled Classic hunting stock with its straight comb is suitable for right-handed as well as left-handed shooters (ambidextrous). The non-slip checkering in new design ensures a sure and stable grip even in rain. The ergonomically designed thumbhole stock made of oiled walnut with satin finish ensures stability in the firing position and a relaxed shooting posture thanks to its roll-over cheek piece and its sharp pistol grip.

The MP R Multi Purpose Beavertail stock, as well as the MS R Silhouette stock are equipped with a stippled checkering. Furthermore, these two stocks are the bridge between the needs of the shooting range and the hunting grounds. The aluminum rail in the forend enables the attachment of accessories, such as a hand stop. These stocks are also prepared for the assembly of a butt plate carrier.

The solid and flat bedding of the barreled action in the stock ensures the highest precision. Just phenomenal details.

Integrated aluminum rail
at MP R and MS R stocks



Receiver made of solid steel



Integrated recoil lug

Solid and flat bedding





ANSCHÜTZ

EINFACH EINS WERDEN!

1727

*FAST, PRECISE
AND ELEGANT*

.17 HMR | .22 l.r.



IMPORTANT SECONDS
FOR HUNTING SUCCESS

**The ANSCHÜTZ
straight pull
barreled action**

1727 F

STRAIGHT-PULL LEADS TO SUCCESS

A straight-pull design means minimal movement in operation and, of course, super-fast cycling of the bolt — both advantages are important when hunting.

With the Model 1727 F we have perhaps the fastest small bore straight-pull model on the market. The precisely crafted barreled action is adapted from our world famous biathlon rifles to meet the needs in the field, dynamic shooting disciplines and on the shooting range.

The result: A high end straight-pull repeating rifle with a target pedigree, aimed for the hunting market.

Fast, precise, elegant.

1727 F

1727 F MODELS – THE PROVEN STRAIGHT PULL ACTION BIATHLON TECHNOLOGY OPTIMISED FOR HUNTING

Wonderfully balanced German stock made of matt oiled walnut. Classic, timeless ergonomics, compact geometry. Subtle hog-back stock with German cheek piece, distinctive schnabel forearm tip. The finely cut checkering on the fore-end underlines the brilliant shooting and repeating performance of the 1727 F: a rifle for lovers of unusual things as well as for technology enthusiasts.



Extremely fast repeating possible by opening the barreled action with the index finger and closing it with the thumb.



German style stock with bavian cheek piece.

ANSCHÜTZ

EINFACH EINS WERDEN!

- 1 Non-slip rubber butt pad
- 2 German style stock, made from aged walnut
- 3 Thumb rest for fast repeating
- 4 Straight pull barreled action in caliber .22 l.r.
- 5 Sliding safety catch
- 6 Non-slip bolt handle
- 7 11 mm prism rail, assembled in the factory
- 8 ANSCHÜTZ Precision barrel
- 9 ReCESsed muzzle, 18 mm
- 10 Studs
- 11 Detachable magazine, easy to exchange
5-shot .22 l.r.
- 12 Straight pull barreled action in caliber .17 HMR
- 13 Non-slip checkering
- 14 Match two stage trigger 5020/1;
90 g - 650 g, factory set at 550 g
- 15 Trigger guard
- 16 Magazine release lever
- 17 Detachable magazine, easy to exchange
4-shot .17 HMR
- 18 Barrel thread ½ Zoll -28 UNEF



Shown: Model 1727 F German stock,
caliber .22 l.r., 560 mm barrel.



Shown: Model 1727 F
German stock, caliber .17 HMR,
457 mm barrel, barrel thread
½" - 28 UNEF.



5-Shot sheet steel
magazine, blued
for caliber .22 l.r.



4-Shot stainless steel
magazine for .17 HMR
caliber.

1727 F MODELS PRODUCT INFORMATION

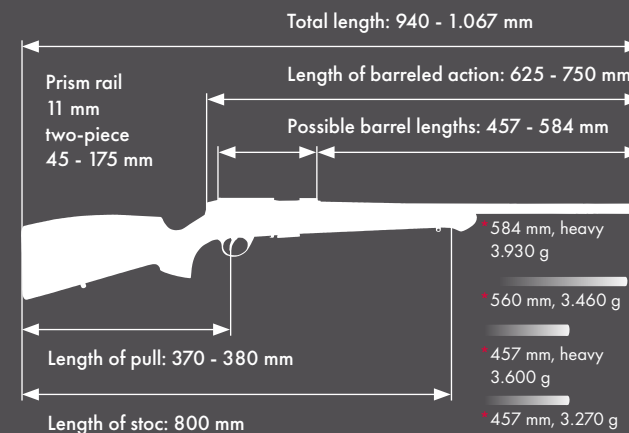

Two stage trigger 5020/1:
factory set at 550 g
adjustable from 90 - 650 g



Total weight,
depending on
barrel length:
3.270 - 3.930 g



Important: Barrel lengths depend on caliber, not all lengths are possible for all calibers. For more information see page 72-73.

Scope of delivery:

Model 1727F configurations are delivered, depending on the desired configuration, with a 4-shot magazine for .17 HMR caliber, 5-shot or 10-shot magazine for .22 l.r. caliber, a thread cap (if barrel with barrel thread is selected), transport rifle case Mega Version II (length 118 cm), original test target and quality control card.

1727 F CONFIGURATOR

ACCORDING TO YOUR WISHES!

Technical data (depending on the configuration):

The total weight is between 3.270 g and 3.930 g.
The total length is between 940 mm and 1.067 mm.

For detailed information, please refer to the „Product information“ section highlighted in gray on the previous product pages.

1. STOCK



German stock - Right hand version

Length of pull370 mm

Material.....Walnut, oiled

Wood classes (S) (P)

2. CALIBER

Caliber .17 HMR

Number of grooves 6

Twist rate..... 9"/228 mm

Receiver..... silver



Caliber .22 l.r.

Number of grooves 8

Twist rate..... 17"/420 mm

Receiver..... black



3. BARREL VERSION

457 mm (18 Inch) Barrel

Length of barreled action625 mm

Muzzle diameter 18 mm

Barrel thread ½ Zoll - 28 UNEF



457 mm (18 Inch) Barrel, heavy

Length of barreled action625 mm

Muzzle diameter21 mm

Barrel thread ½ Zoll - 28 UNEF



560 mm (22 Inch) Barrel

Length of barreled action728 mm

Muzzle diameter 18 mm



584 mm (20.3 Inch) Barrel, heavy

Length of barreled action752 mm

Muzzle diameter21 mm

Barrel thread ½ Zoll - 28 UNEF



584 mm
barrel only
with caliber
.22 l.r.

Scope of delivery:

Your rifle configuration, incl. transport rifle case Mega Version II (length 118 cm), original test target and quality control card.



4. TRIGGER



Two stage trigger 5020/1
Factory set at550 g
Adjustment range...90 g - 650 g

5. MAGAZINE



Magazine Standard
4-Shot magazine
for caliber .17 HMR
made of high-strength
and robust stainless steel.



Magazine Standard
5-Shot magazine
for caliber .22 l.r.
made of robust,
blued sheet steel.



Magazine 10-Shot
10-Shot magazine
for caliber .22 l.r.
made of robust,
blued sheet steel.

6. WOOD GRADES

Wood grade Standard (S)*



Wood grade Premium (P)*



7. TRIGGER BLADE



Serrated trigger blade
Black, can be swiveled
and moved forwards
and backwards.

*All wood grades shown are only examples. Wood is a natural product. Deviations in grain, wood structure and color within the ANSCHÜTZ wood quality grades are possible. The availability of the wood classes depends on the respective stock design. Further information at www.anschuetz-sport.com



THE MEASURE OF ALL
THINGS IN BIATHLON

**A real pleasure
on the hunt**

1727 F

FOR THE TECHNOLOGY ENTHUSIAST

Highly complex interplay of precision mechanics and materials, of high-tech, state-of-the-art manufacturing and know-how. Everything in the smallest of spaces. Created to lead the will to the finish – with maximum safety and outstanding precision.

Like no other name, ANSCHÜTZ stands for progress in biathlon - over 95 % of all athletes trust in ANSCHÜTZ. For decades, the straight pull barreled action was developed to perfection and then optimized for hunting.

The fastest follow-up shots in an almost unchanged shooting position are the result - for training on the shooting range and hunting success.

1727 F ACTION

SOLID CORE PIECE

Globally adapted receiver from the biathlon. High-quality coatings: silky smooth (bolt!), particularly resistant (to the effects of weather) and protected against corrosion. Ideal for hunting. The robust receiver carries two 11 mm prism rails for flexible mounting of various hunting optics.



1727 F BOLT FOR THE OLYMPICS

World-famous and winner of several Olympic gold medals at biathlon: the straight pull action. Seven hardened steel balls for a secure lock. The easy-grip, knurled bolt handle, optimised for hunting, enables incredibly fast follow-up shots: The index finger opens - the thumb closes. The movement is made from the wrist, the trigger hand remains on the rifle.

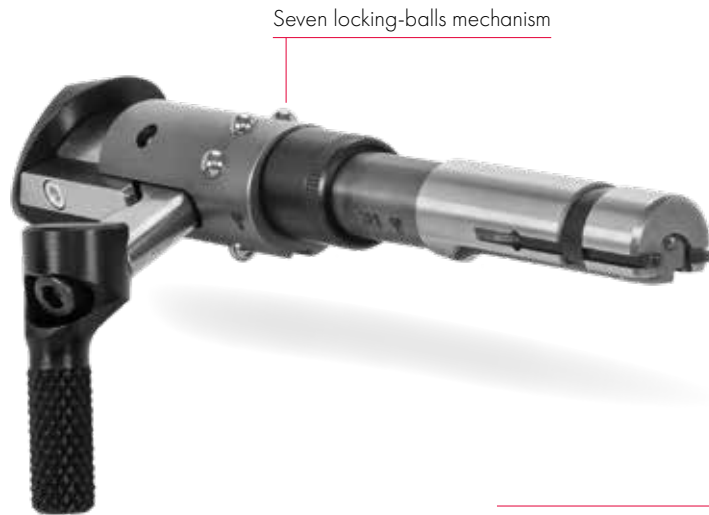

Seven locking-balls mechanism

.22 l.r. Magazine, made of blued sheet steel, 5-Shot

1727 F MAGAZINE SAFELY INTEGRATED

Securely engaged, the magazine disappears almost invisibly into the stock. Made of weather-resistant steel (.17 HMR) or blued sheet steel (.22 l.r.), the magazine defies dust, dirt and water and feeds loaded cartridges precisely and quickly.



1727 F TRIGGER THE BENCHMARK FOR SPORTING RIFLE TRIGGERS

Finest lapping, low weight, specially hardened: a precision piece of extreme robustness. Fine adjustable trigger weight (90 g to 650 g) for target-oriented interaction of the entire action.

The most important part of the rifle in such a decisive moment: High-precision parts in harmony in the smallest space for a single task - to form the perfect "interface", the interface between man and rifle. Close to unique and meanwhile adapted by other manufacturers.

There is nothing better.



Sliding safety catch

Two stage trigger 5020/1,
90 - 650 g, factory set at 550 g.

.17 HMR Magazine,
stainless steel, 4-Shot

Adjustable trigger blade



ANSCHÜTZ

EINFACH EINS WERDEN!



SOUND MODERATOR

**Protect your hearing, reduce stress,
shoot better, hunt more relaxed**

ANSCHÜTZ SOUND MODERATOR OBM48*

COMPACT. EFFECTIVE. ROBUST.

This sound moderator with its very high attenuation performance of 32-37 dB (depending on caliber) is an excellent choice for all standard calibers. The slim design, which also proves advantageous when used with attachments, and the low weapon extension make this model an excellent all-rounder. These factors and the high-quality material used make this sound moderator a reliable companion with an excellent price-performance ratio.

In order to keep the length of your hunting rifle with screwed-on sound moderator as short as possible, 73 mm of the total length of the sound moderator is attached above the barrel. This lengthens your firearm with the sound moderator screwed on by only 132 mm.



Overall length of the sound moderator: 205 mm

Total extension of the rifle: 132 mm



Sound moderator shown in original size, scale 1:1



Back



Front



Thread adapter and guide washer fitted ex works, can be replaced if necessary.

OPERATING PRINCIPLE

HOW DOES THE OBM48 WORK?



After a shot, the gases in the propellant charge expand and escape at the end of the barrel. A sound moderator inhibits this through various chambers and specially shaped structures. Our sound moderator OBM48 offers the hot, high-pressure gases flowing out of the muzzle a space in which the extremely high pressure can be reduced. When the gases escape from the sound moderator into the environment, the much lower pressure results in an audibly quieter bang. The more volume the sound moderator provides for this, the greater the expansion effect.

This achieves a significant reduction in the muzzle blast of up to **32-37 dB (decibels)** depending on the caliber used. The volume ratio of the sound moderator also causes a frequency modulation, which makes the perceptible bang sound much duller. Another major advantage of our sound moderator is the clear and noticeable reduction in recoil and the almost complete elimination of visible muzzle flash.

Less shooting stress and therefore better results - with the ANSCHÜTZ high performance sound moderator.

SOUND MODERATOR .22 l.r.*

MAKES QUIET EVEN QUIETER



The sound moderator manufactured exclusively for ANSCHÜTZ by the well-known Swiss manufacturer B&T AG has been specially developed for small-caliber rifles in 4,5 - 5,5 mm caliber. The sound moderator made of robust aluminum is prepared for the 1/2"-20 UNF barrel thread.



Sound moderator
For caliber .22 l.r., suitable for barrel thread 1/2"-20 UNF.
Item No.: 013290

SOUND MODERATOR

PRODUCT INFORMATION

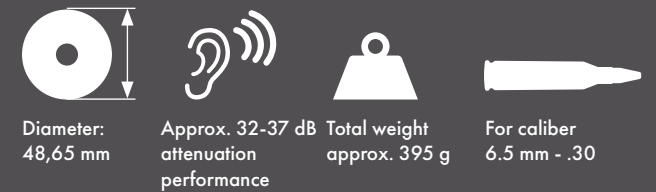
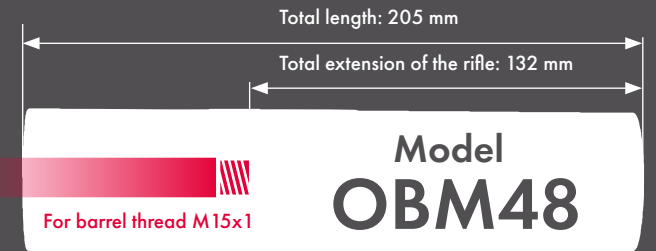

Item Number:
Sound moderator OBM48, cal. 6.5 mm - .30 017300

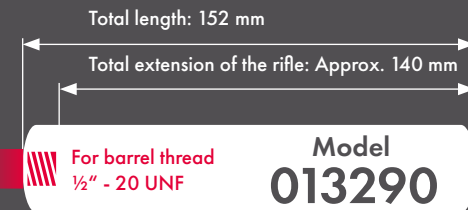

Item Number:
Sound moderator for caliber 4,5 - 5,5 mm 013290

*** Important information:** Please observe the regulations of the Weapons Act applicable in your country.

OVERBARREL

ONBARREL





ANSCHÜTZ

EINFACH EINS WERDEN!

ACCESSORIES AND MERCHANDISE

**The finishing touch for your
ANSCHÜTZ hunting rifle**

ANSCHÜTZ ACCESSORIES

MAGAZINES



1782 Magazine, replacement

Different number of shots depending on the caliber.

Item No.: 015338

3-Shot, cal. .308 Win., .243 Win., 6.5 Creedmoor

Item No.: 015337

3-Shot, cal. .30-06, 8x57 IS, 9,3x62

Item No.: 016165

2-Shot, cal. .300 Win. Mag.



1782 Driven hunt magazine

Different number of shots depending on the caliber.

Item No.: 015257

5-Shot, cal. .308 Win., .243 Win., 6.5 Creedmoor

Item No.: 015367

5-Shot, cal. .30-06, 8x57 IS, 9,3x62

Item No.: 015893

3-Shot, cal. .300 Win. Mag.

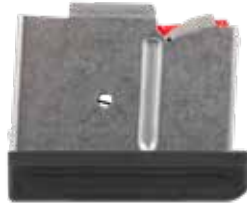

1771 Magazine, replacement

Different number of shots depending on the caliber.

Item No.: 014781

5-Shot, cal. .17 Hornet

Item No.: 015069

3-Shot, cal. .22 Hornet

Item No.: 014188

4-Shot, cal. .222 Rem. / .223 Rem. / .204 Ruger



1771 DJV Magazine, replacement

Different number of shots depending on the caliber.

Item No.: 016882

5-Shot, cal. .17 Hornet

Item No.: 014925

3-Shot, cal. .22 Hornet

Item No.: 014931

4-Shot, cal. .222 Rem. / .223 Rem. / .204 Ruger



1761 Magazine, replacement

For different calibers.

Item No.: 015081

5-Shot, cal. .17 HMR

Item No.: 015079

5-Shot, cal. .22 Lr. und .17 Mach2

Item No.: 015080

5-Shot, cal. .22 WMR



1761 10-Shot Magazine

Made of high-strength stainless steel and synthetic material.

Item No.: 016174

10-Shot, cal. .22 Lr.



1771 Single shot adapter

Optimally suited for the shooting range.

Item No.: 012059



1761 Magazine loader

Allows easy and fast loading of the 1761 magazine.

Item No.: 015298



1727 F Magazine, replacement

4-Shot, caliber .17 HMR

Item No.: 012961



1727 F Magazine, replacement

5-Shot, caliber .22 Lr.

Item No.: 001153



1727 F 10-Shot Magazine

10-Shot, caliber .22 Lr.

Item No.: 001154



1727 F Single shot adapter

For caliber .22 Lr.

Item No.: 001485

FIRING PINS, BOLT BREECHES, TRIGGER BLADES AND GUARDS



Trigger blade "Standard"
Silver-colored, nickel-plated trigger blade with non-slip serrations, is fitted as standard on all 1782 models.
Item No.: 016343



Trigger blade "Gold Line"
Gold-colored TiN-coated trigger blade with non-slip serrations, the eye-catcher on your 1782.
Item No.: 016515



Trigger blade "Black Line"
Deep black DLC-coated trigger blade without serrations, the simple but elegant detail on your 1782.
Item No.: 016833



Trigger blade "Gilded"
Gold-coated trigger blade without serrations, an exclusive and luxurious highlight for your 1782.
Item No.: 017138



Trigger blade "1761 APR"
Black trigger blade for the tuning trigger of the 1761 model series.
Item No.: 016301



1761 Trigger guard
Made from high-strength aluminum. Elegantly shaped, a high-quality extra for eternity.
Item No.: 015182



Firing pin 1782 "Gold Line"
Gold-colored TiN-coated firing pin, an exceptional and extremely robust and durable extra for your 1782.
Item No.: 017087 (only for new orders)



Bolt breech 1782 "Gold Line"
Gold-colored TiN-coated bolt breech, maximum abrasion resistance and luxurious look thanks to the proven all-round coating.
Item No.: 017080 (only for new orders)



Bolt breech 1782 "Black Line"
Deep black DLC-coated bolt breech with maximum gliding properties for a fabulously smooth bolt movement of your bolt action rifle.
Item No.: 016828 (only for new orders)

ANSCHÜTZ ACCESSORIES

BOLT KNOBS AND THREAD CAPS



Bolt knob Synthetic
25 mm diameter, black.
Item No.: 003301



Bolt knob Steel
25 mm diameter, black.
Item No.: 013807



Bolt knob Walnut
20 mm or 25 mm diameter.
Item No.: 016509 (Ø 25 mm)
Item No.: 016510 (Ø 20 mm)



Bolt knob Black Line
Deep black DLC-coated
(Diamond Like Carbon),
diameter 25 mm.
Item No.: 016808



Bolt knob Checkering
With knurled checkering,
timelessly elegant in black,
25 mm diameter.
Item No.: 016827



Bolt knob APR
For fast repeating,
with non-slip grooves,
made of high-strength aluminum.
Length 40 mm, Ø 22 mm
Item No.: 016881



**Bolt knob
Gold star**
With knurled checkering,
gold lines and elegant
gold star, 25 mm diameter.
Item No.: 016817



**Bolt knob
Checkering and lines**
With knurled checkering
and elegant, timeless gold
or silver lines, 25 mm diameter.
Item No.: 016821 (gold)
Item No.: 016819 (silver)



**Bolt knob
Lines**
With elegant, timeless gold
or silver lines, 25 mm diameter.
Item No.: 016825 (gold)
Item No.: 016823 (silver)



**Thread cap
Gold or silver lines**
With elegant, timeless
gold or silver lines,
for barrel thread M15x1.
Item No.: 016832 (gold)
Item No.: 016830 (silver)



Thread caps, replacement
With knurled checkering, different diameters and threads depending
on the model and barrel design. Model 1782 - Barrel thread M15x1,
Model 1771 - Barrel thread M15x1, Model 1761 - Barrel thread ½ Inch-20 UNF
or ½ Inch-28 UNEF, Model 1727 - Barrel thread ½-28 UNEF (19 or 21 mm).
Item No.: 013920 (M15x1, 18 mm diameter)
Item No.: 015026 (½ Inch-20 UNF, 19 mm diameter)
Item No.: 013739 (½ Inch-28 UNEF, 18 mm diameter)
Item No.: 014161 (½ Inch-28 UNEF, 21 mm diameter)

ANSCHÜTZ ACCESSORIES

MOUNTS AND PICATINNY RAILS

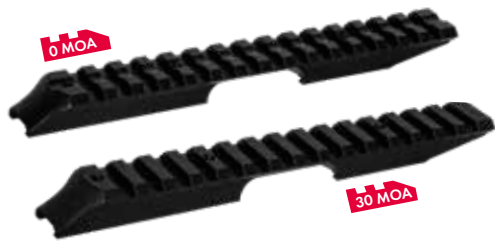

1761 Picatinny rail

For mounting various optics on 1761 models.
With 30 or 0 MOA pretilt.

Item No.: 015018 (0 MOA)

Item No.: 016989 (30 MOA)



1771 Picatinny rail

For mounting various optics on 1771 models.
With 30 or 0 MOA pretilt.

Item No.: 015255 (0 MOA)

Item No.: 017026 (30 MOA)



Recknagel one-piece tip-off mount

With triangular nut incl. special tool, suitable for picatinny rails, ring width 15 mm, available with different center tube diameters (MR) and heights (BH).

Item No.: 018206 (30 mm MR, 10,5 mm BH)

Item No.: 018207 (30 mm MR, 15,5 mm BH)

Item No.: 018208 (34 mm MR, 10,5 mm BH)

Item No.: 018209 (34 mm MR, 17,5 mm BH)



Recknagel tip-off mount

With triangular nut incl. special tool, suitable for picatinny rails.

Item No.: 018210 (30 mm center tube diameters)

Item No.: 018211 (34 mm center tube diameters)



Recknagel PSG-tip-off mount - ZEISS

Made of high-strength aluminium, black anodized, with triangular nut incl. special tool, suitable for picatinny rails. For 45°/Zeiss inner rail, particularly low overall height.

Item No.: 016472



Recknagel PSG-tip-off mount - SWAROVSKI

Made of high-strength aluminium, black anodized, with triangular nut incl. special tool, suitable for picatinny rails. For Swarovski SR inner rail, particularly low overall height.

Item No.: 018212



Recknagel one-piece tip-off mount

Made of high-strength aluminum, black hard-anodized, with triangular nut incl. special key, extremely stable and very low, suitable for Picatinny rails, bolt spacing 110 mm, total length 130 mm for 45°/Zeiss inner rail.

Item No.: 018213

ANSCHÜTZ ACCESSORIES

STOCKS



1782 Classic - Stock only

Made of oiled walnut with straight cheek piece and rubber recoil pad, incl. fittings.

Item No.: 015345 (right)

Item No.: 015997 (left)



1782 Classic PRO - Stock only

Made of oiled walnut with adjustable cheek piece and rubber recoil pad, incl. fittings.

Item No.: 015982 (right)

Item No.: 016000 (left)



1782 Classic PRO Black - Stock only

Made of oiled walnut with black, adjustable cheek piece and rubber recoil pad, incl. fittings.

Item No.: 017099 (right)



1771 German stock - Stock only

Made of oiled walnut with bavarian cheek piece, schnabel tip and rubber recoil pad, incl. fittings.

Item No.: 015435 (right)



1771 Thumbhole stock - Stock only

Made of oiled walnut with roll-over cheek piece, schnabel tip und rubber recoil pad, incl. fittings.

Item No.: 015436 (right)



1771 GRS Sporter - Stock only

Made of laminated wood, with adjustable cheek piece and rubber recoil pad, incl. fittings.

Item No.: 015437 (right)



1761 Classic - Stock only

Made of oiled walnut with straight cheek piece and rubber recoil pad, incl. fittings.

Item No.: 015530 (right)

Item No.: 015556 (left)



1761 Thumbhole stock - Stock only

Made of oiled walnut with roll-over cheek piece, schnabel tip und rubber recoil pad, incl. fittings.

Item No.: 015531 (right)



1761 Monte Carlo - Stock only

Made of oiled walnut with Monte Carlo roll-over cheek piece, schnabel tip und rubber recoil pad, incl. fittings.

Item No.: 015938 (right)



1782 German stock - Stock only

Made of oiled walnut with bavarian cheek piece, schnabel tip and rubber recoil pad, incl. fittings.

Item No.: 015346 (right)



1782 Thumbhole stock - Stock only

Made of oiled walnut with roll-over cheek piece, schnabel tip und rubber recoil pad, incl. fittings.

Item No.: 015464 (right)



1782 GRS Bifrost - Stock only

Made of fiberglass-reinforced composite material, with adjustable cheek piece and rubber recoil pad, incl. fittings.

Item No.: 017024 (right)



1771 DJV - Stock only

Made of oiled walnut with adjustable cheek piece and rubber recoil pad, incl. fittings.

Item No.: 015438 (right)

1727

1727 German stock - Stock only

Made of oiled walnut with bavarian cheek piece, schnabel tip and rubber recoil pad, incl. fittings.
For 1727 F barreled action caliber .17 HMR or .22 l.r.

Item No.: 017271 (Stock only for barreled actions caliber .17 HMR)

Item No.: 017278 (Stock only for barreled actions caliber .22 l.r.)



1761 Monte Carlo II - Stock only

Made of oiled walnut with Monte Carlo roll-over cheek piece, schnabel tip und rubber recoil pad, incl. fittings.

Item No.: 015939 (right)



1761 MPR - Stock only

Made of stained hardwood with checkering, beavertail fore-end and aluminum rail. Incl. adjustable rubber butt plate, prepared for attaching a clamp piece for a butt plate carrier and fittings.

Item No.: 015532 (right)

Item No.: 015774 (left)



1761 MSR - Stock only

Made of oiled walnut with checkering, beavertail fore-end and aluminum rail. Incl. adjustable rubber butt plate, prepared for attaching a clamp piece for a butt plate carrier and fittings.

Item No.: 015533 (right)

ANSCHÜTZ ACCESSORIES

SOUND MODERATORS, STOCK AND BARREL ACCESSORIES AND CLEANING



ANSCHÜTZ Sound moderator OBM48 für Kal. 6.5 mm - .30*

This sound moderator with its very high attenuation performance of 32-37 dB (depending on caliber) is an excellent choice for all standard calibers. The slim design, which also proves advantageous when used with attachments, and the low weapon extension make this model an excellent all-rounder. More information on page 80.

Item No.: 017300



ANSCHÜTZ Sound moderator .22 l.r.*

The sound moderator manufactured exclusively for ANSCHÜTZ by the well-known Swiss manufacturer B&T AG has been specially developed for small-caliber rifles in 4,5 - 5,5 mm calibre. The sound moderator made of robust aluminum is prepared for the 1/2"-20 UNF barrel thread.

Item No.: 013290



1771 Barrel weight 365 g

Ensures optimum balance and comfortable swinging in disciplines such as "running boar". Length 116 mm for barrel diameter 19 mm with barrel thread M15x1.

The barrel weight is mounted "overbarrel" and therefore does not extend the overall length.

Item No.: 014684



Thread adapter

From inner thread 1/2" - 20 UNF to outer thread 1/2" - 28 UNEF.

Item No.: 013483



Thread adapter for 1761 barrels with open sight and inner thread

From inner thread M12x1 to outer thread 1/2" - 20 UNF.

Item No.: 016511



Sling swivel (2 Pieces)

For quick and easy assembly of a rifle sling.

Item No.: 007663



Cleaning rod guide 1761

Protects the cartridge chamber and the trigger unit from scratches, cleaning agents and residues from the barrel, made of high-strength synthetic.

Item No.: 015655



Cleaning rod guide 1727

Protects the cartridge chamber and the trigger unit from scratches, cleaning agents and residues from the barrel, made of robust aluminum.

Item No.: 013711

ANSCHÜTZ ACCESSORIES

TRANSPORT



ANSCHÜTZ Special soft case for hunting and sporting rifles

As a special feature, the new carrying strap system, including a lock, also lets you carry the soft case on your back.

Outer dimensions: 1.250 x 250 x 50 mm

Item No.: 015504



ANSCHÜTZ Transport gun case MEGA

For 2 rifles with accessories, black with ANSCHÜTZ logo. Empty weight: approx. 3.5 kg, Outer dimensions: 1.200 x 360 x 115 mm, inner dimensions: 1.185 x 340 x 90 mm.

Two thick foam trays protect your hunting rifle from bumps reliably.

Item No.: 013330



ANSCHÜTZ Sports Bag – 800 x 400 x 340 mm

Can be opened in the middle with a zipper and provides an excellent overview of your luggage. With lockable, one-piece compartment. The pull-out handle and the skater wheels offer maximum comfort during your journey. A robust synthetic base prevents deformation and protects your luggage from bumps. Volume 108 l.

Item No.: 007954

ANSCHÜTZ Backpack

The sporty backpack that will be helpful in everyday life. The large interior and the attached front pocket offer plenty of storage. Large zippers for easy using. Quickly adjustable shoulder strap system to adjust the size optimally. The backpack has rubber feet to put the backpack down safely.

Item No.: 007229



ANSCHÜTZ ACCESSORIES

CLOTHING AND MERCHANDISE



ANSCHÜTZ Caps

Made of robust fabric that is ideal for hunting and all outdoor activities. The size of the cap can be adjusted. With an elegant ANSCHÜTZ leather patch or embroidery.

Item No.: 011690

ANSCHÜTZ - Cap Hunting - brown

Item No.: 015805

ANSCHÜTZ - Cap Hunting - green

Item No.: 001568

ANSCHÜTZ - Cap Sport - black



ANSCHÜTZ Signal vest

With a large and smooth zipper on the front. Thanks to the generous cut, the signal vest can be put on quickly and easily. The ANSCHÜTZ logo is on the left chest and on the back.

Item No.: 015725



ANSCHÜTZ Fan vest

Stylish and practical UhlSPORT multifunctional jacket with the ANSCHÜTZ logo printed on the left chest. The jacket can also be worn as a vest thanks to the detachable sleeves. 100% polyester.

Item No.: 016710 Size S

Item No.: 016711 Size M

Item No.: 016712 Size L

Item No.: 016713 Size XL



ANSCHÜTZ Shooting vest

Offers numerous big pockets to comfortably put in your equipment. The size of the vest can be adjusted using length adjustment with press buttons on the back and the stretch material incorporated into the sides of the vest. Velcro straps on the back allow to attach a towel or similar quickly and easily. Clips on the back offer the option of attaching a number plate during competitions.

Item No.: 015692 Size S

Item No.: 015693 Size M

Item No.: 015694 Size L

Item No.: 015695 Size XL

Item No.: 015696 Size XXL



ANSCHÜTZ T-Shirt "Deer and .300 Win. Mag."*

The high-quality T-shirt made of elastic fabric (95% cotton, 5% elastane) with deer design on the front and 1782 slogan "Think Powerful" on the back.

Item No.: 016199 "Deer" Size XL

Item No.: 016200 "Deer" Size XXL

*Only as long as available!



ANSCHÜTZ Glasses

If you want to enjoy your drink in style, you should not only pay attention to the quality of the drink, but also choose a suitable glass!

With ANSCHÜTZ engraving.

Item No.: 016201 (Wine glass)

Item No.: 016250 (Champagne glass)

Item No.: 016217 (Long drink glass)

ANSCHÜTZ

ANSCHÜTZ

ANSCHÜTZ

EINFACH EINS WERDEN!

ANSCHÜTZ

EINFACH EINS WERDEN!



ANSCHÜTZ Logo Pin

Attachable pin with ANSCHÜTZ logo. Width: 20 mm; aluminum.

Item No.: 011832

ANSCHÜTZ Logo key chain

Made of robust stainless steel and therefore resistance to dust, dirt and water. 50 mm x 12 mm.

Item No. 016157



ANSCHÜTZ T-Shirt "Oryx" and .300 Win. Mag."*

The high-quality T-shirt made of elastic fabric (95% cotton, 5% elastane) with oryx design on the front and 1782 slogan "Think Powerful" on the back.

Item No.: 016838

"Oryx" Size M

Item No.: 016837

"Oryx" Size L

Item No.: 016836

"Oryx" Size XL

Item No.: 016239

"Oryx and Think Powerful" Size S

Item No.: 016240

"Oryx and Think Powerful" Size M

Item No.: 016241

"Oryx and Think Powerful" Size L

Item No.: 016242

"Oryx and Think Powerful" Size XL

Item No.: 016243

"Oryx and Think Powerful" Size XXL

*Only as long as available!



ANSCHÜTZ cleaning pad for hunting and sporting guns

Soft and cushioning cleaning pad for hunting and sporting guns. With attractive ANSCHÜTZ 1782 motif. Hem stitched in black, prevents parts such as screws from rolling down during maintenance and cleaning work. The pad can also be used as a mousepad.

Item No.: 016764 English Version



1782 Safari
Kaliber .300 Win. Mag.

by Anschütz Custom Shop



ANSCHÜTZ

EINFACH EINS WERDEN!

CUSTOM SHOP

**Custom designed ANSCHÜTZ hunting rifles
are an investment for generations**

ANSCHÜTZ CUSTOM SHOP **INDIVIDUAL MASTERPIECES**

Give your ANSCHÜTZ rifle your own personalised mark. A high-quality custom designed hunting rifle is an investment that will be appreciated for generations. We can bring to life your experiences and memories or realize your artistic hunting style on an ANSCHÜTZ rifle. Whether you decide on an extensive deep relief or a restrained fine scroll engraving, or an elegant signature on the trigger guard, let us craft a special piece for you. If you want to extensively embellish a rifle, to create a one-of-a-kind item of rare and collectable value. The engravings shown are only examples.

Our Custom Shop will be happy to coordinate your individual wishes with you.



ANSCHÜTZ

EINFACH EINS WERDEN!



ANSCHÜTZ

EINFACH EINS WERDEN!

2016



1984

1955



1950



1914



1901



1856



GRUSS aus
SCHÜTZ



ANSCHÜTZ

EINFACH EINS WERDEN!

***PERFECTION
IS TRADITION
SINCE 1856***

ANSCHÜTZ

EINFACH EINS WERDEN!

J.G. ANSCHÜTZ GmbH & Co. KG Jagd- und Sportwaffenfabrik

Daimlerstraße 12 · 89079 Ulm / Germany
Fon +49 - (0)731 - 40 12 - 0
Fax +49 - (0)731 - 40 12 - 700
www.anschuetz-sport.com
www.facebook.com/OfficialAnschuetz
www.youtube.com/AnschuetzGmbH
www.instagram.com/AnschuetzGmbH

Your dealer:

COMMITTED TO PRECISION **SINCE 1856**

You can always rely on an ANSCHÜTZ hunting bolt action rifle. Your ANSCHÜTZ rifle will be a reliable companion for you at all times, with unsurpassed precision and functionality. This is what the name ANSCHÜTZ stands for.

Numerous Olympic champions, World and European champions as well as over 97% of all biathletes and target shooters in the whole world trust in this ANSCHÜTZ precision. You too can benefit from over 165 years of experience in the field, which has been incorporated into our hunting bolt action rifle, just as you can benefit from the experience of car manufacturers in racing.

For us hunter at ANSCHÜTZ, our products have long been more than just a daily companion through the hunting year - they are the center of our passion.

**ANSCHÜTZ wishes
you a good hunting.**



Jochen Anschütz
President

E 02/24 · Production and model changes reserved · All colors and sizes approximate · Supply of firearms only to the holders of purchasing permit · Misprints, errors and prior sale also reserved © ANSCHÜTZ

ANSCHÜTZ, the ANSCHÜTZ logo, the ANSCHÜTZ logo in connection with the words "Die Meister Macher" and "Einfach Eins Werden" (also in a different way of writing) are protected trademarks of J.G. ANSCHÜTZ GmbH & Co. KG, Ulm, Germany. The use of these symbols is prohibited without the consent of J.G. ANSCHÜTZ GmbH & Co. KG inadmissible and punishable by law.

JAGD